

MDS-10

Operator Training



Course Outline

References:

- A. MDS-10 Operations Manual
- B. MDS-10 Field Guide

Lesson 1 – System Overview & Quick Start

Lesson 2 – User Interface & Setup Options

Lesson 3 – MD, GPR Overview & Search Techniques

Lesson 4 – Accessories, Trouble Shooting & Maintenance

Operator Confirmation Exercise

Lesson 1

System Overview & Quick Start



MD & GPR Fundamentals

Metal Detection

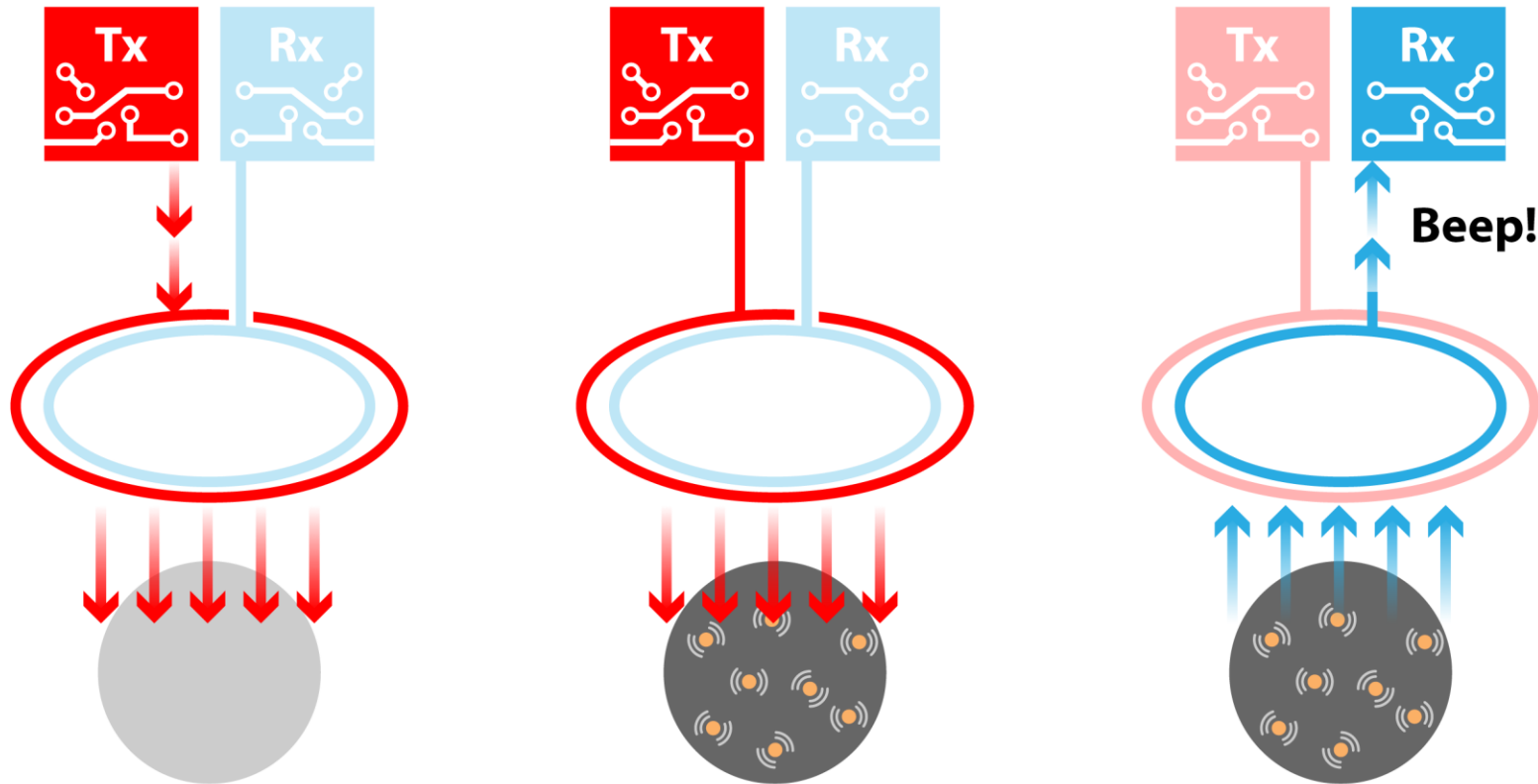

Advantages*

- Detects all conductive metal targets
- Ignores non metal clutter
- Provides information on target composition

Disadvantages*

- Suffers in mineralised ground (Ground Balance)
- Cannot detect non-metal non-conductive targets
- Difficult to discriminate between targets
- Prone to false alarms (false positives and negatives)

* Typical metal detection technology

MD & GPR Fundamentals

Ground Penetrating Radar (dielectric anomaly detector)

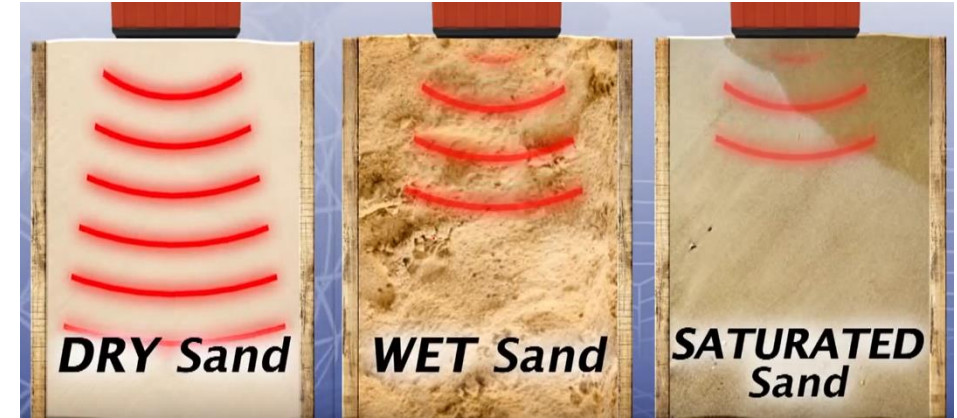
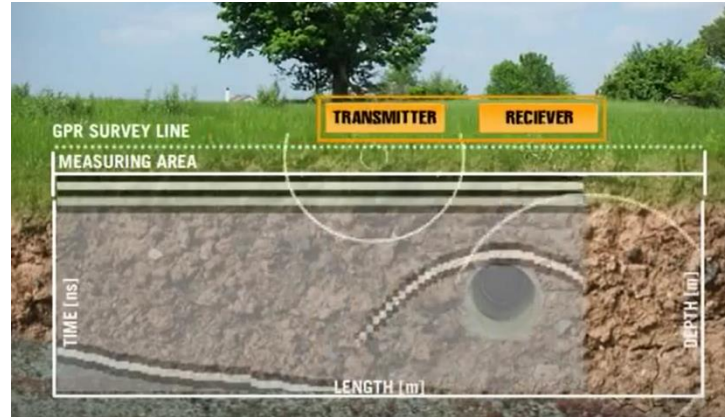

Advantages

- Detects non-metal targets
- Can provide indication of depth

Disadvantages

- Depth of detection can vary depending on ground
- Cannot distinguish between ground anomalies
- Prone to false alarms
- Difficult to discriminate between targets

MDS-10 Dual Sensor Detector

MDS-10 combines unique Metal Detection (MD) and Ground Penetrating Radar (GPR) technologies to provide superior results in the detection of buried metal and non-metal explosive device components Including:

- Wires
- Improvised explosive devices
- Landmines
- Cluster munitions
- Unexploded ordnance

- **Rugged and Compact**
- **Ease of Use**
- **Safe**



MDS-10 General Specifications & Features

- Variable Metal Detection and Ground Penetrating Radar sensitivity with volume control
- Detection, Interrogation and Pinpointing modes
- Fully enclosed and protected cables
- Fast and accurate location of targets
- Continuous real-time display of Metal Detection and Ground Penetrating Radar detections with the ability to pause graphical image for increased scrutiny of potential target
- Tactical Mode for night operations
- Waterproof — IP68
- Adjustable search head
- Selectable audio, haptic (vibration) and visual operator alerts
- Li-ion battery often used in Tier 1 military radios and optional AA battery pack
- Battery charger
- Hard case and soft carry bag
- Compatible with night vision goggles
- Intuitive user interface ensures operator training is kept to a minimum of time
- GPR transmission automatically stops when the detector is not in use by the operator



MDS-10 General Specifications & Features

Detector Dimensions	Collapsed: 485 × 152 × 195 mm Extended: 1567 × 275 × 195 mm
Detector Weight	2.8 kg (6.2 lbs)
Li-ion Battery	6.8 Ah Battery Life: >7 hours
AA Battery Pack	For use with AA alkaline or rechargeable batteries
Detection Alerts	All alerts independently configurable, Audio Speaker, Audio Headphones, MD and GPR target Indicators (with Night Vision Goggles compatibility), Vibration Motor (Haptic feedback) and Colour LCD 3.5" with Night Vision Mode
Waterproof	≤3 meters
Standards	MIL-STD-810G
EMC	MIL-STD-461G
IP Rating	IP68
Operating Temperature	-30°C to +60°C
Storage Temperature	-50°C to +80°C
Metal Detection Sensor	Technology: Simultaneous Multi-Frequency Digital Coil: 269 × 191 mm Mono Transmit, Figure 8 Receive Coil MD Modes: Detection / Interrogation / Pinpointing Calibration: Ground Balance and Noise Cancel
Ground Penetrating Radar	Technology : Ultra-Wide Band (UWB) Impulse Radar Calibration: Skyshot (2–3 seconds calibration time)



MDS-10 Kit Contents

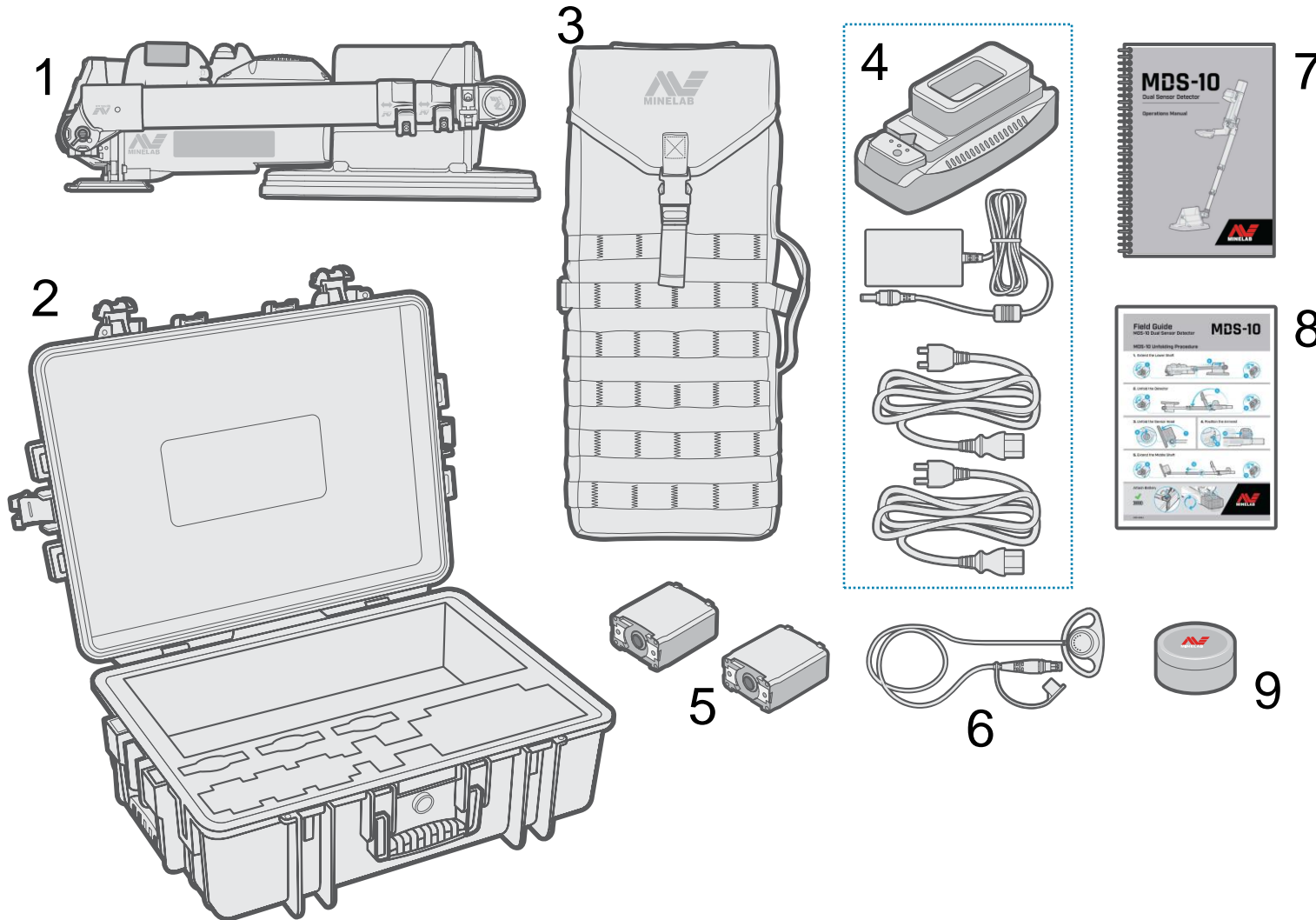

Standard Items

1. MDS-10 Detector
2. Hard Transit Case
3. Carry Bag
4. Battery Charger
5. Lithium-ion Battery (x 2)
6. MDS-10 Earset
7. Operations Manual
8. Field Guide
9. GPR Test Target

MDS-10 Kit Contents

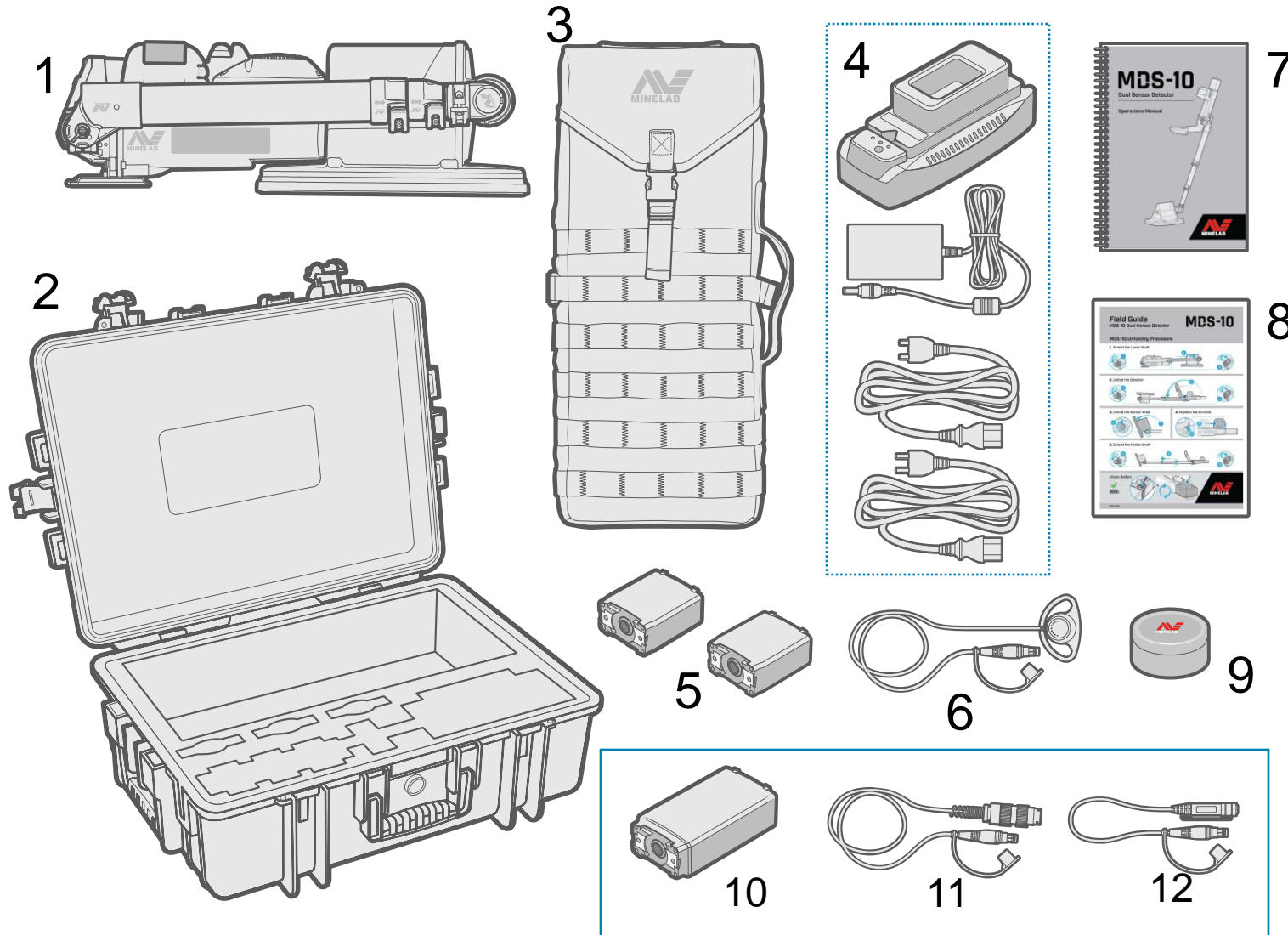

Standard Items

1. MDS-10 Detector
2. Hard Transit Case
3. Carry Bag
4. Battery Charger
5. Lithium-ion Battery (x 2)
6. MDS-10 Earset
7. Operations Manual
8. Field Guide
9. GPR Test Target

Optional Items

10. AA Battery Pack
11. Radio Adaptor Cable
12. 3.5mm (1/8") Audio Adapter Cable

MDS-10 Unfolding Procedures

1. Extend the Lower Shaft

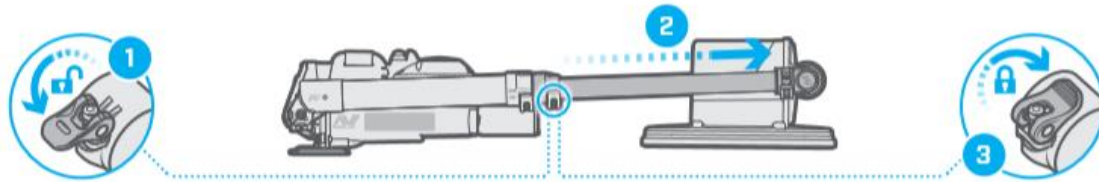

2. Unfold the Detector

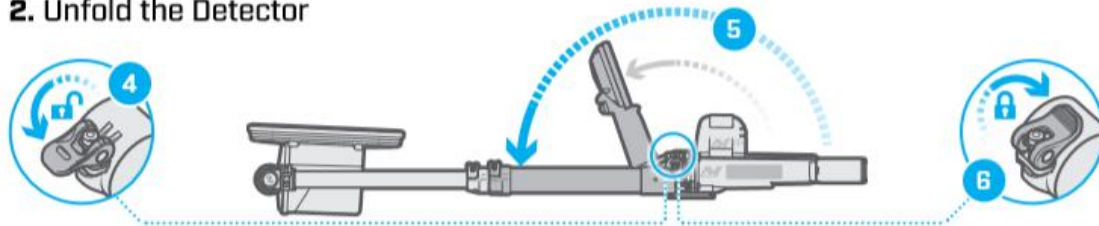

3. Unfold the Sensor Head

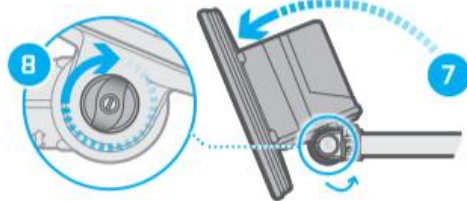

4. Position the Armrest

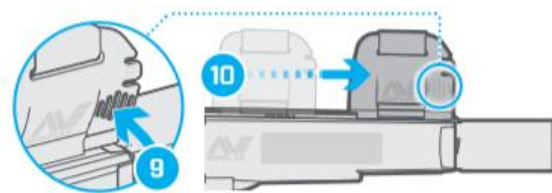

5. Extend the Middle Shaft

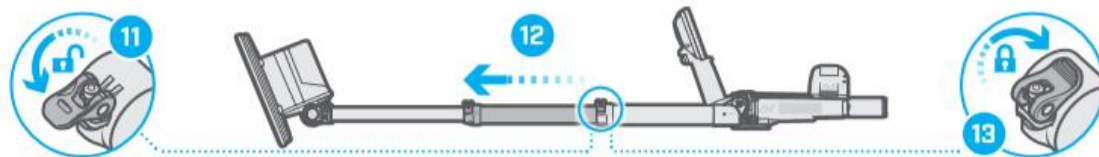

Attach Battery

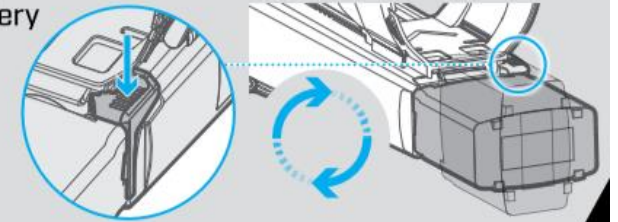

Attach Earset

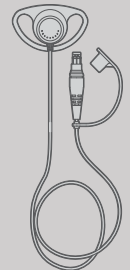
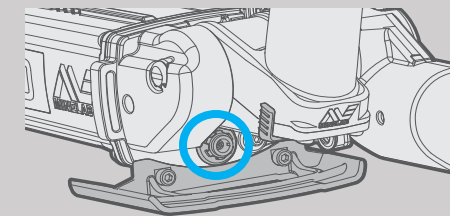

MDS-10 Description & Identification

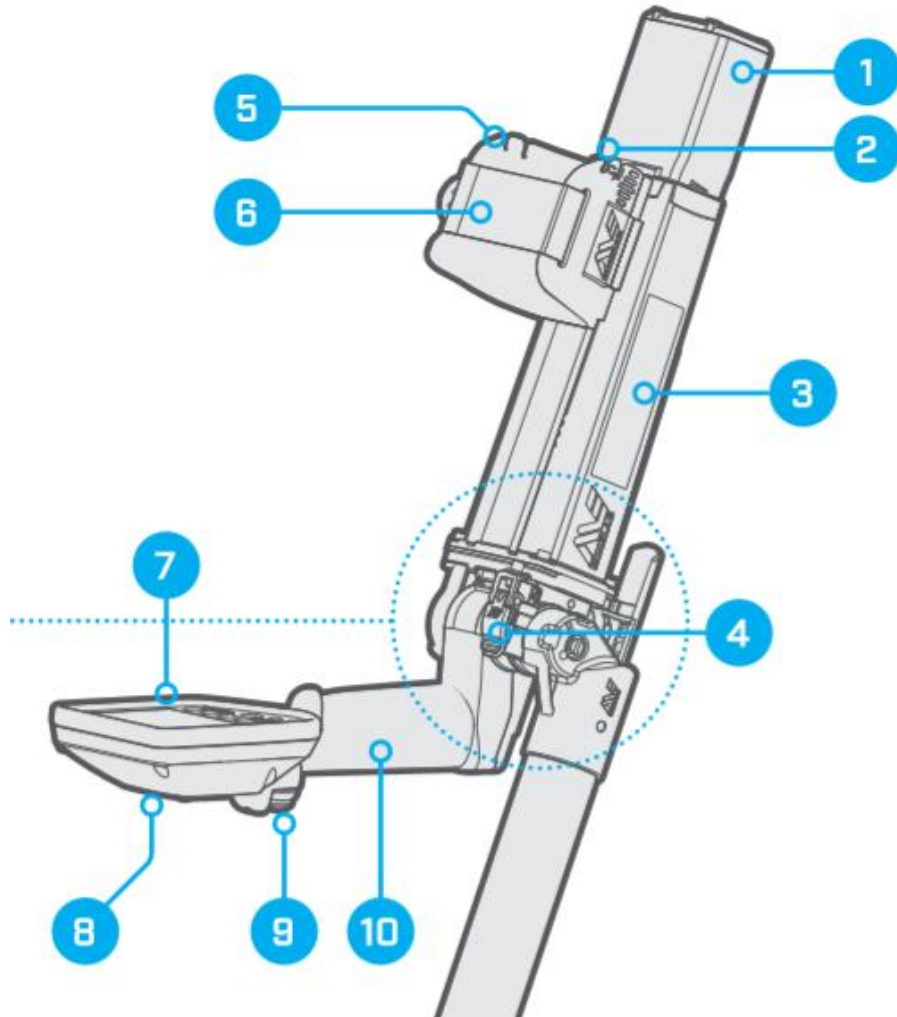

1. Lithium-ion Rechargeable Battery
2. Battery Release Lever
3. Control Box
4. Lateral Shaft Camlock
5. Adjustable Armrest
6. Armrest Strap
7. User Interface
8. Speaker
9. Trigger Button
10. Folding Handle

MDS-10 Description & Identification

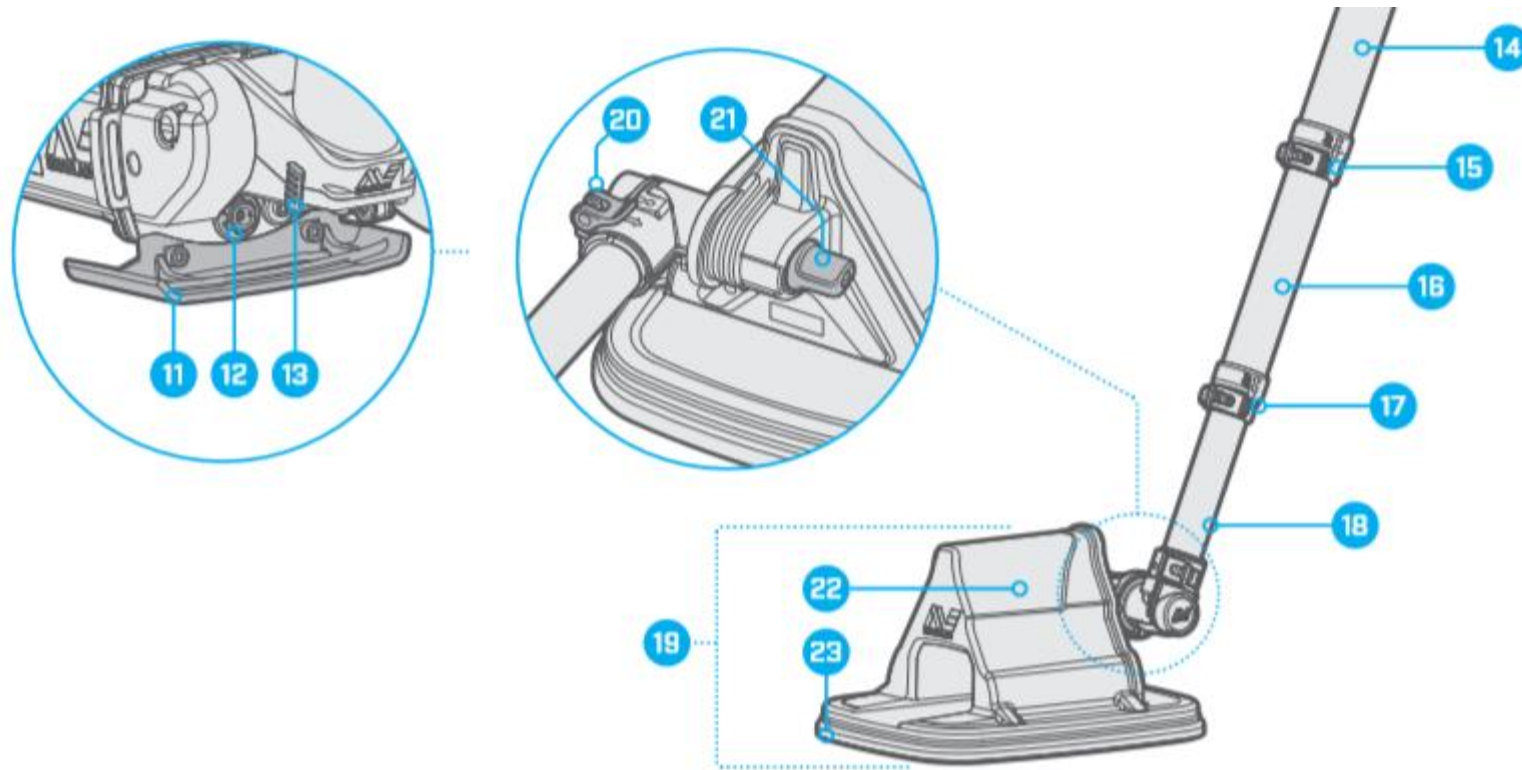

- 11. Stand
- 12. Earset Connector
- 13. MD Test Piece
- 14. Upper Shaft
- 15. Upper Shaft Camlock
- 16. Middle Shaft
- 17. Lower Shaft Camlock
- 18. Lower Shaft
- 19. Sensor Head
- 20. Sensor Head Rotation Camlock
- 21. Sensor Head Pivot Tension
- 22. GPR Antennas
- 23. Metal Detection Coil

MDS-10 User Interface

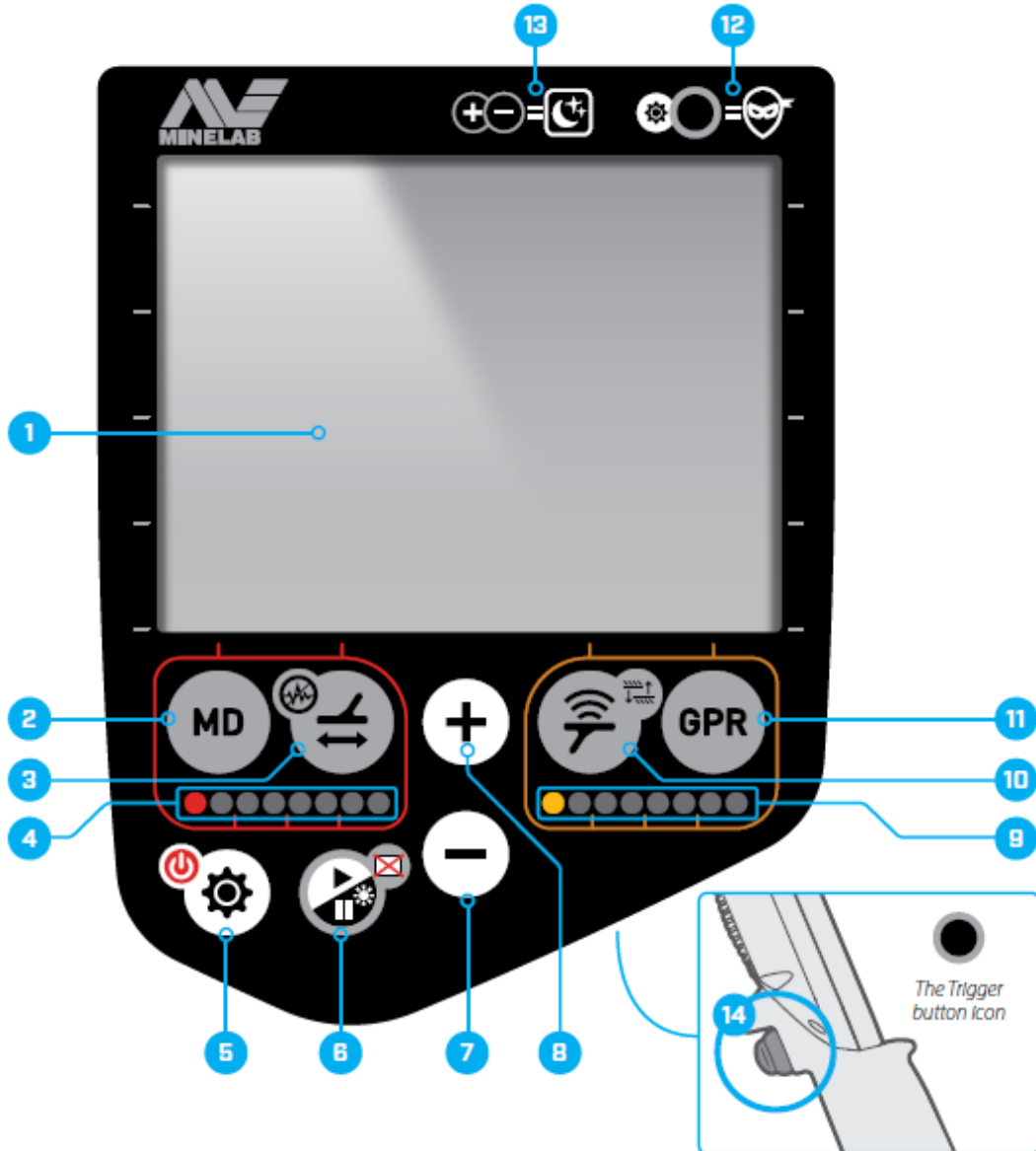

- The MDS-10 User Interface has a large LCD Screen, a backlight, and a keypad.
- The User Interface displays and controls all of the detector functions.

1. LCD
2. MD Button
3. Ground Balance Button/Noise Cancel
4. MD Target Indicator LEDs
5. Setup Button
6. Play/Pause Button – Blank Screen
7. Minus Button
8. Plus Button
9. GPR Target Indicator LEDs
10. Skyshot Button/GPR Adjustments
11. GPR Button
12. Tactical Mode Buttons Reference
13. Night Vision Mode Buttons Reference
14. Trigger

MDS-10 User Interface

SWITCH ON – SELECT SENSORS

Purpose: Switch detector ON and OFF and select MD and/or GPR sensors

- Long press on ON/OFF button to switch ON and OFF
- Single press of MD or GPR to select or deselect
- Both MD and GPR cannot be deselected at the same time
- Pressing and hold ON/OFF button for more than five seconds to restore to factory presets.



MDS-10 User Interface

GROUND BALANCE

Purpose: Remove MD sensor noise caused by ground mineralisation

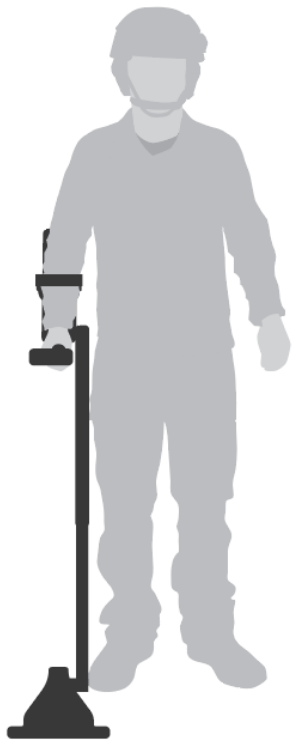

Hold detector 25-50mm
(1-2") above surface



Press and release
Ground Balance button

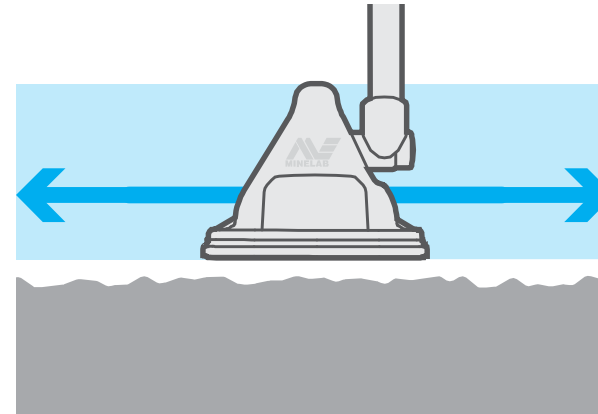

Slowly move search head
over ground at same height

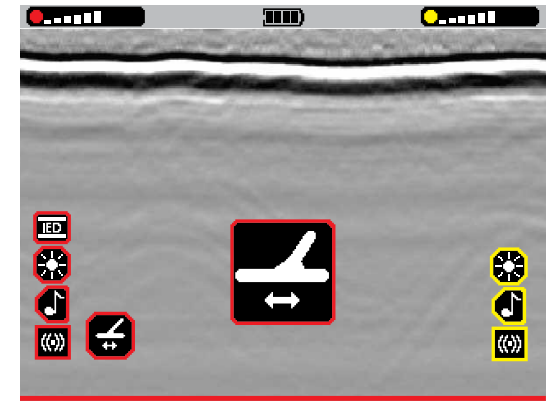

Observe Ground
Balance progress screen

Note:

GB cannot be started until first LED on MD sensor stops flashing after switching detector ON

MDS-10 User Interface

SKYSHOT

Purpose: Remove GPR's own radar signature to clear screen imagery and optimise GPR performance

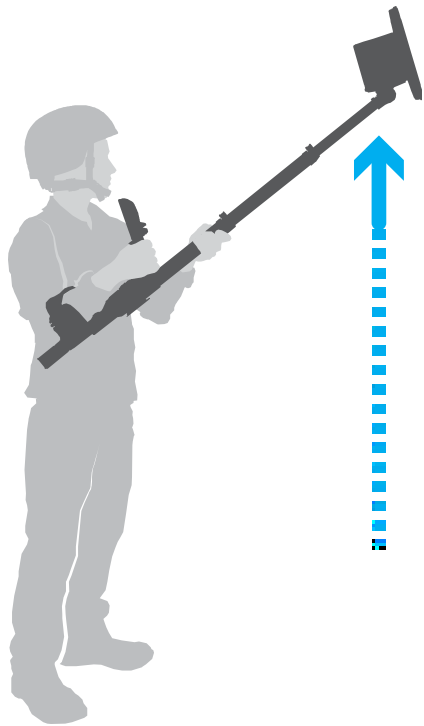

Hold detector in air away from all objects



Press and release Skyshot button

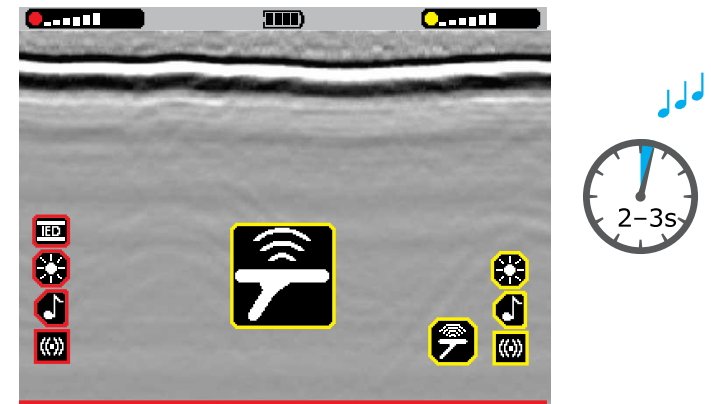

Note:
Skyshot cannot commence until first LED on GPR sensor stops flashing after switching detector ON

Observe Skyshot progress screen

MDS-10 Quick Start (Both Sensors Enabled)

1. Turn On

Long-press the Setup button.

Wait for the first MD Target Indicator LED to stop flashing.



2. MD Ground Balance

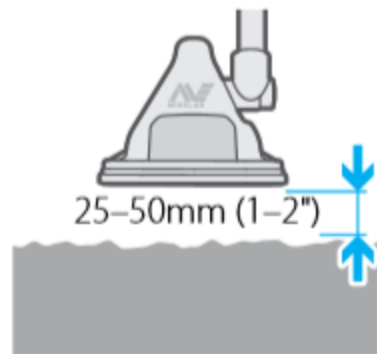

MDS-10 Quick Start (Both Sensors Enabled)

3. GPR Skyshot

Ensure that the first GPR Target Indicator LED has stopped flashing.



4. MD Test Piece

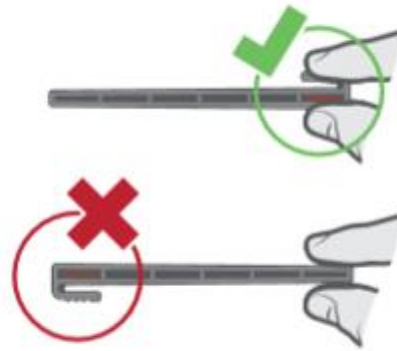
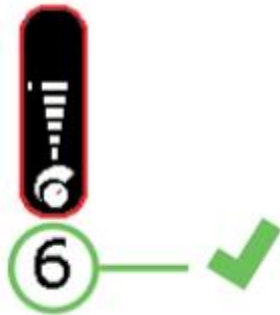

MDS-10 Quick Start (Both Sensors Enabled)

5. GPR Test Target

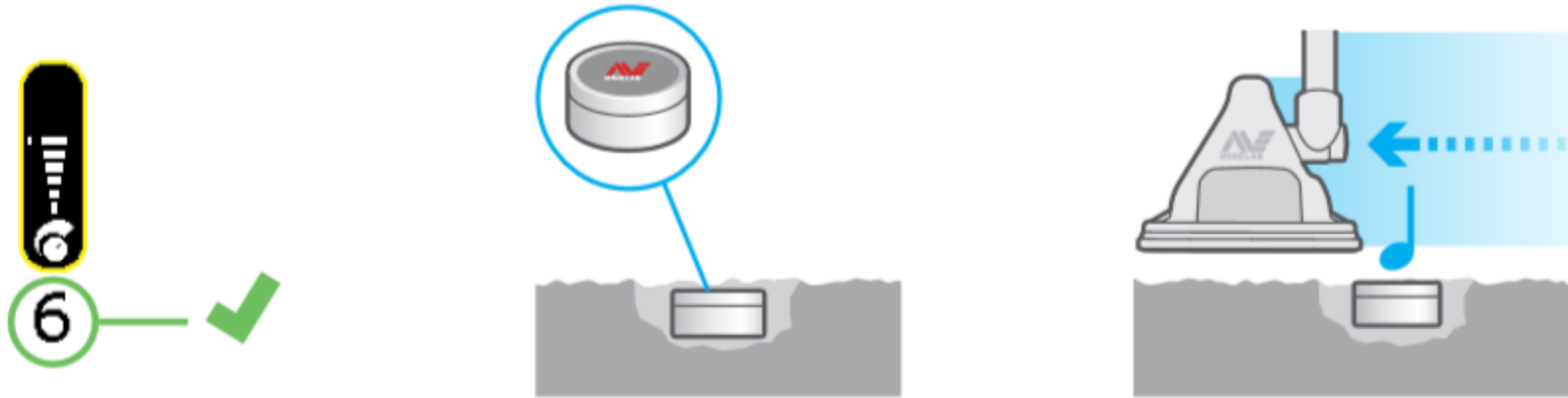

6. Begin Detecting

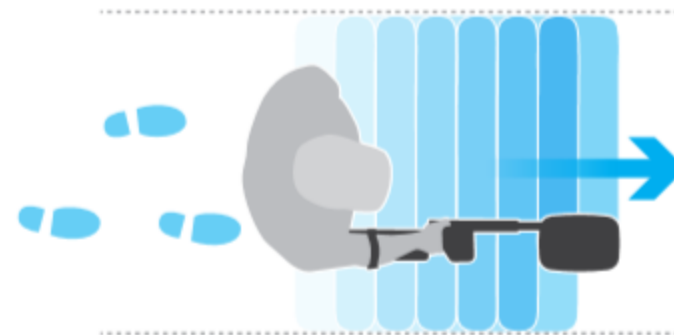

MDS-10 Detect Screen

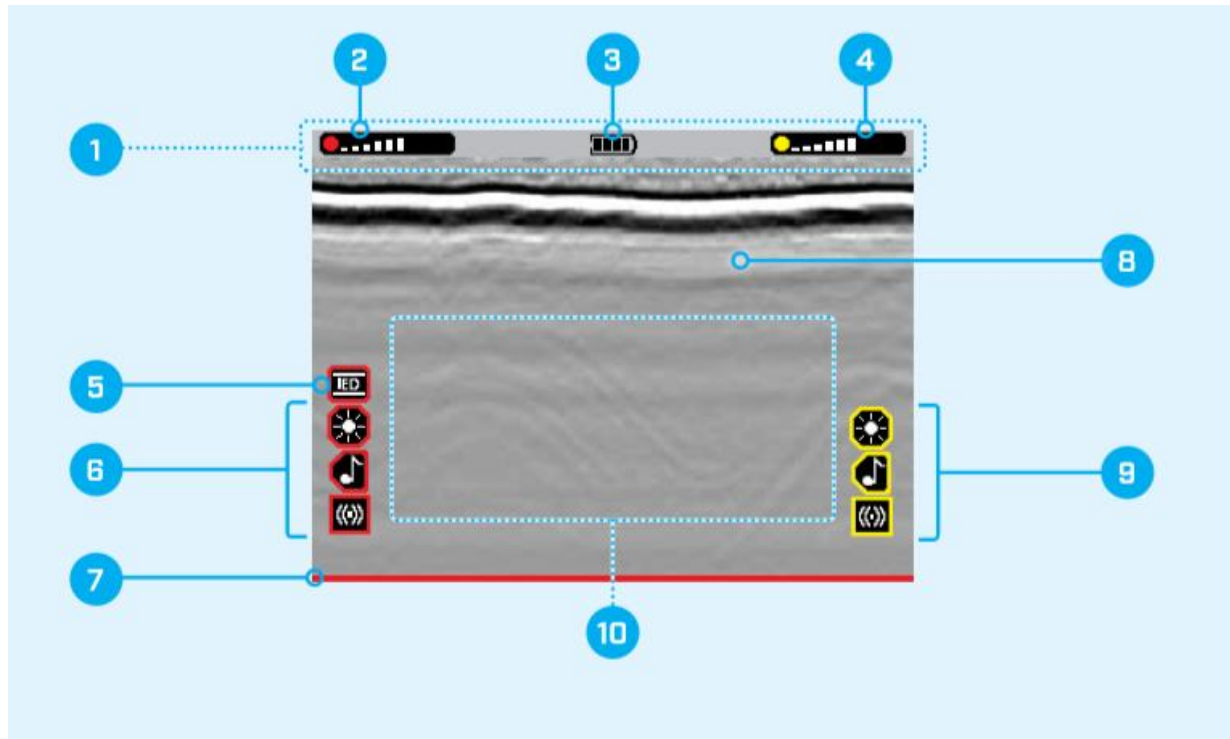

1. Status Bar
2. MD Sensitivity Level Indicator
3. Battery Level Indicator
4. GPR Sensitivity Level Indicator
5. MD Ground Balance Mode
6. Enabled MD Feedback Indicators
7. MD Trace
8. GPR Imagery
9. Enabled GPR Feedback Indicators
10. Pop-up Indications Area

MDS-10 Setup Screen

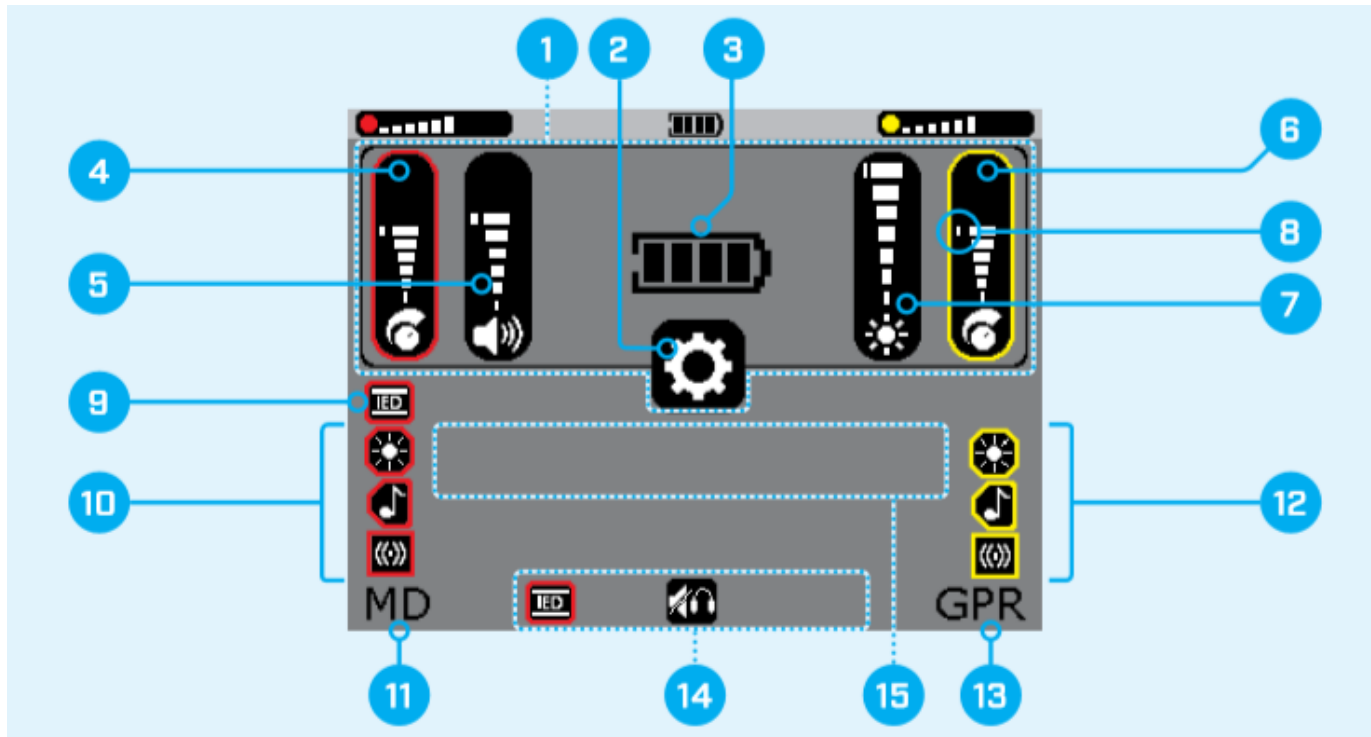

1. Setting Overview Area
2. Setup Menu Icon
3. Battery Level Indicator
4. MD Sensitivity Level
5. Volume Level
6. GPR Sensitivity Level
7. LCD/LED Brightness Level
8. Default Setting Markers
9. MD Ground Balance Mode
10. Enabled MD Feedback Indicators
11. MD Setup Page Indicator
12. Enabled GPR Feedback Indicators
13. GPR Setup Page Indicator
14. Soft Key Options
15. Error Code Display Area

Lesson 2

User Interface & Setup Options



MDS-10 User Interface

SWITCH ON – SELECT SENSORS

Purpose: Switch detector ON and OFF and select MD and/or GPR sensors

- Long press on ON/OFF button to switch ON and OFF
- Single press of MD or GPR to select or deselect
- Both MD and GPR cannot be deselected at the same time
- Pressing and hold ON/OFF button for more than five seconds to restore to factory presets.



MDS-10 User Interface

GROUND BALANCE

Purpose: Remove MD sensor noise caused by ground mineralisation

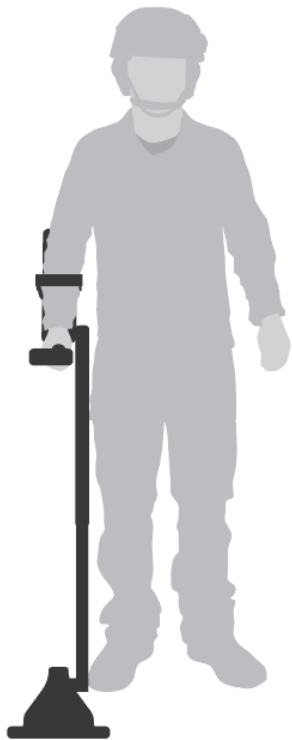

Hold detector 25-50mm
(1-2") above surface



Press and release
Ground Balance button

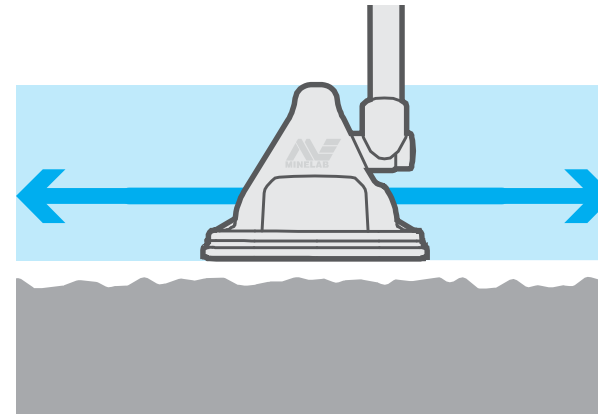

Slowly move search head
over ground at same height

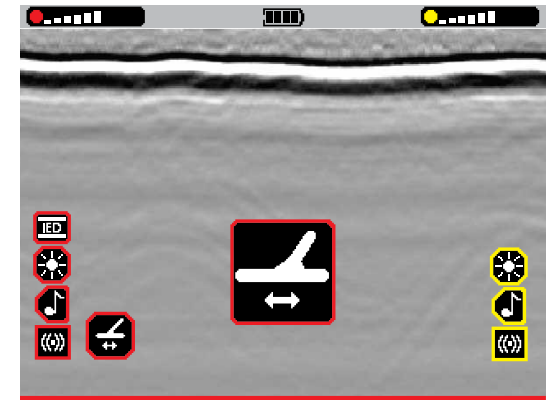

Observe Ground
Balance progress screen

Note:

GB cannot be started until first LED on MD sensor stops flashing after switching detector ON

MDS-10 User Interface

NOISE CANCEL

Purpose: Remove/reduce electrical interference with MD sensor

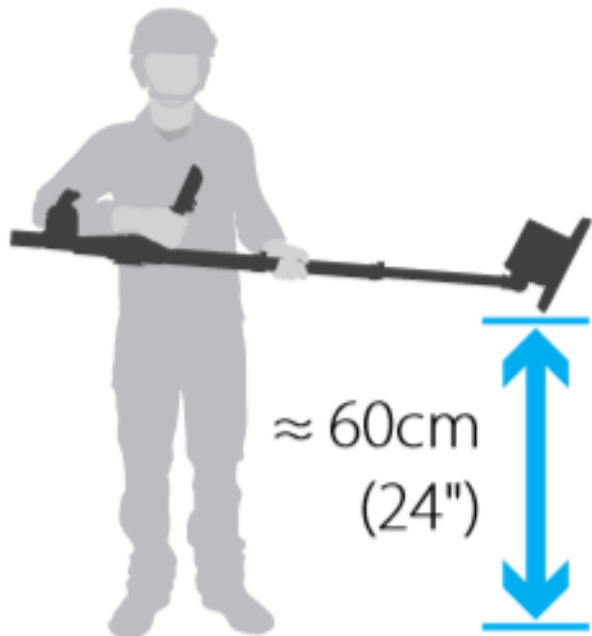

Hold detector horizontally and stationary

Long press and release Ground Balance Button to enter into Noise Cancel

Observe Noise Cancel progress screen 25 seconds

MDS-10 User Interface

SKYSHOT

Purpose: Remove GPR's own radar signature to clear screen imagery and optimise GPR performance

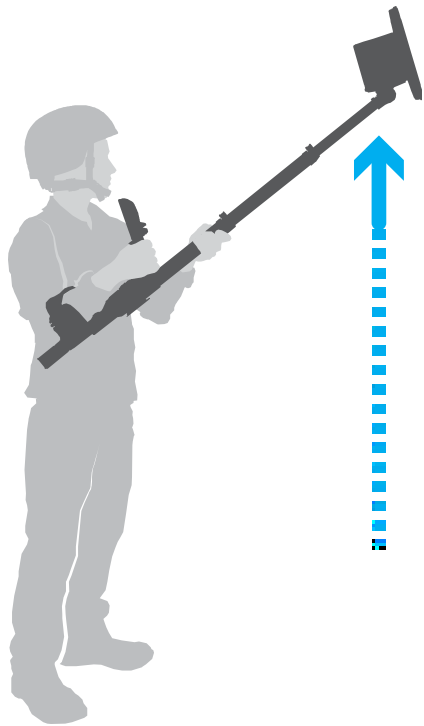

Hold detector in air away from all objects



Press and release Skyshot button

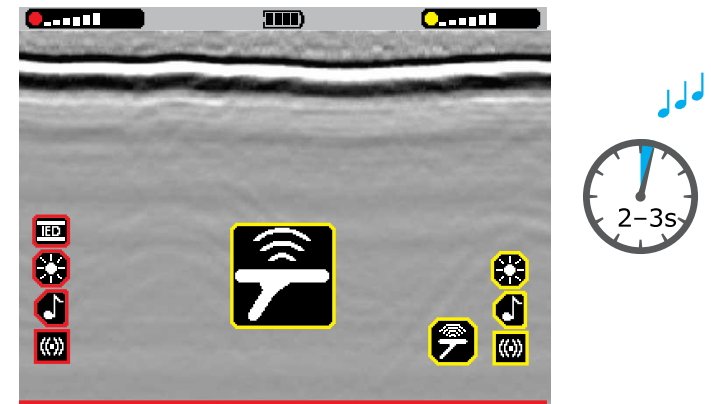

Note:
Skyshot cannot commence until first LED on GPR sensor stops flashing after switching detector ON

Observe Skyshot progress screen

MDS-10 User Interface

VOLUME & SENSOR SENSITIVITY

Purpose: Adjust audio volume, MD and GPR sensitivities

Volume

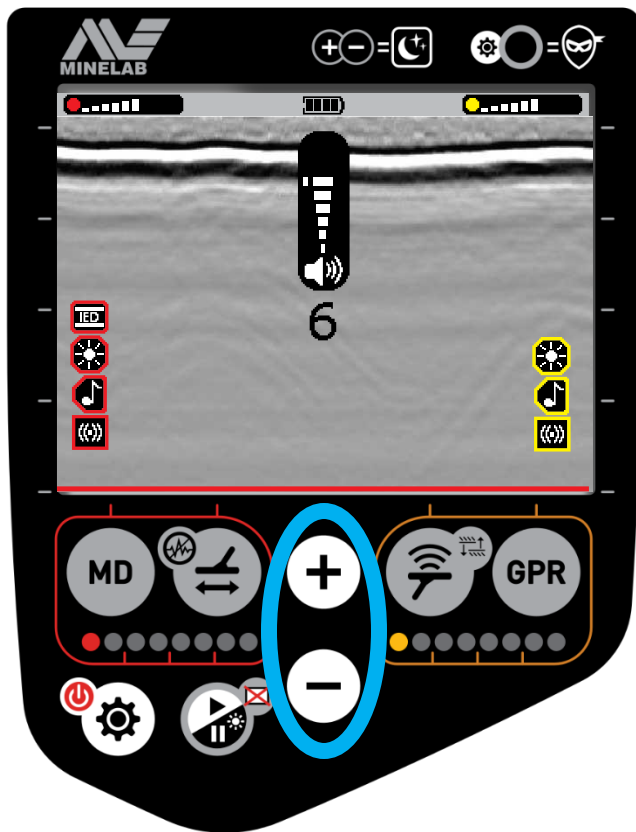

Press + and - buttons to adjust

MD Sensitivity

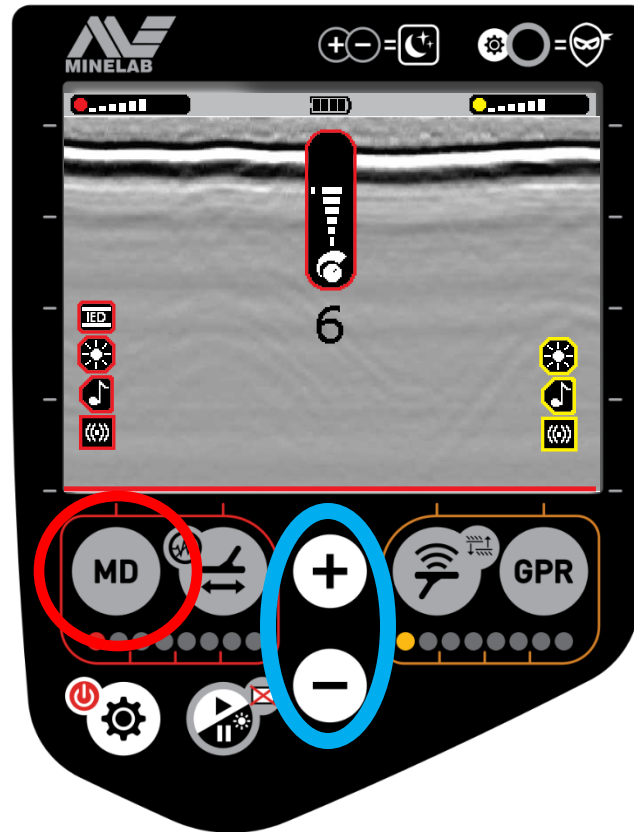

Press and release MD button then + and - buttons to adjust

GPR Sensitivity

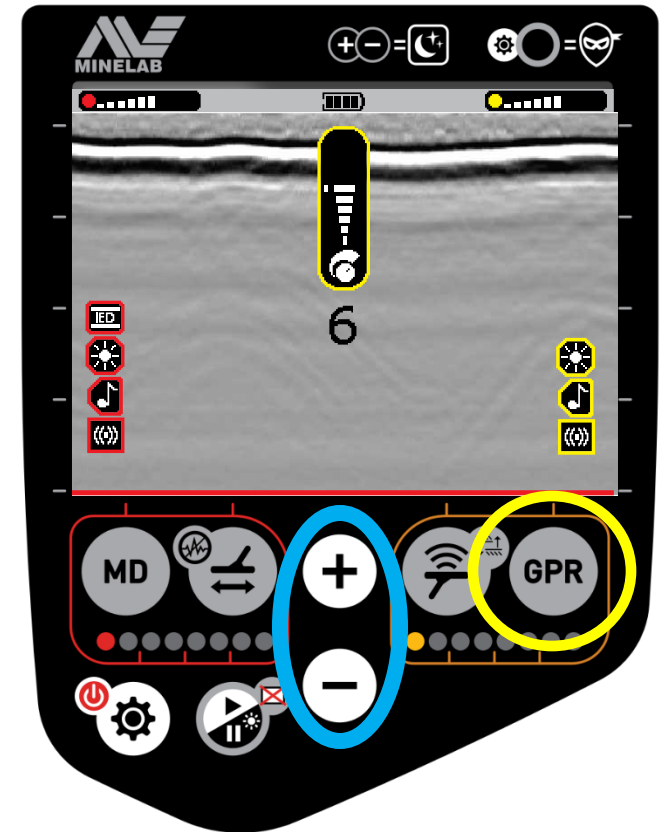

Press and release GPR button then + and - buttons to adjust

MDS-10 User Interface

PAUSE & SCREEN BRIGHTNESS

Purpose: Pause screen, adjust brightness or extinguish screen

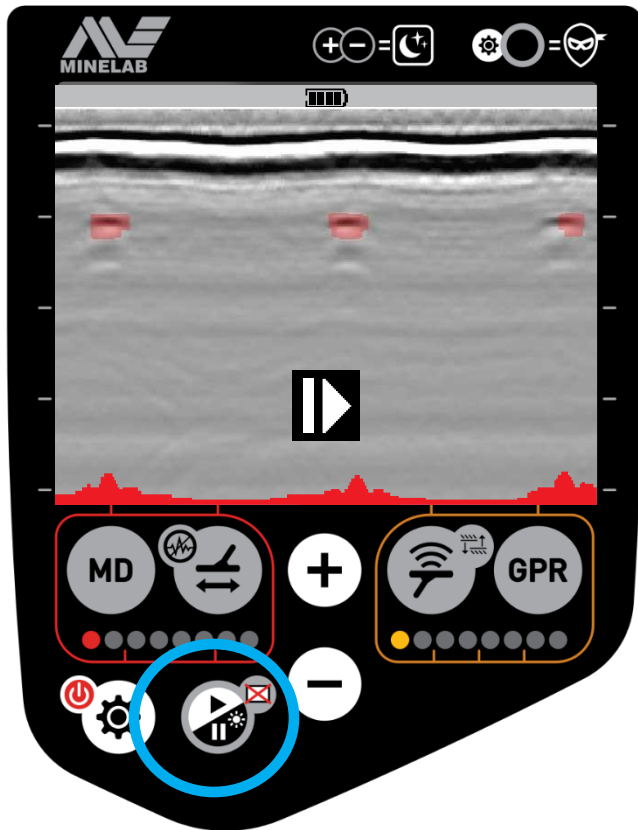

Press and release Pause button – repeat to Play

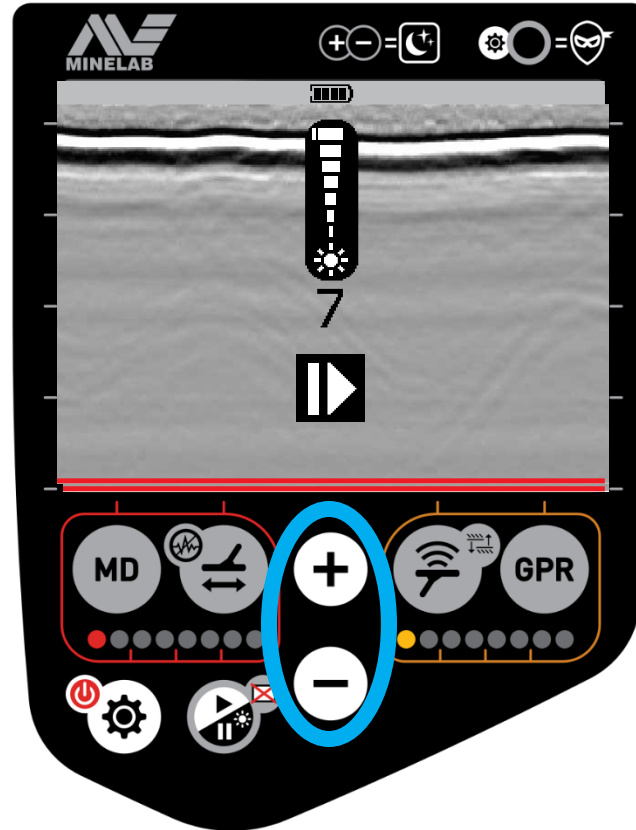

Press + and – buttons to adjust brightness

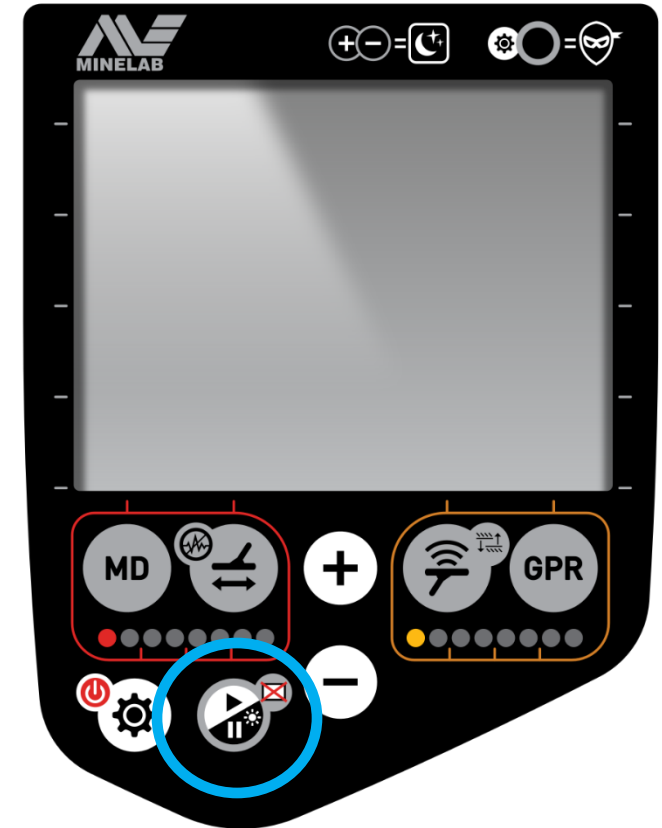

Press and hold Pause button to extinguish screen – repeat to illuminate

MDS-10 User Interface

NIGHT VISION & TACTICAL MODE

Purpose: Allow for use of Night Vision Goggles and reduce alerts to vibration only for tactical purposes

Night Vision

LCD and Target Indicator LED
Switch to night Vision Mode
visible only at night with NVIS

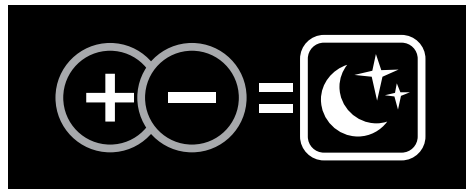

Press + and - simultaneously to
enter into Night Vision Mode -
repeat to remove



Tactical

- Speaker off – Earset on
- LCD and LEDs to Night Vision Mode
- Vibration on
- Immediately selectable

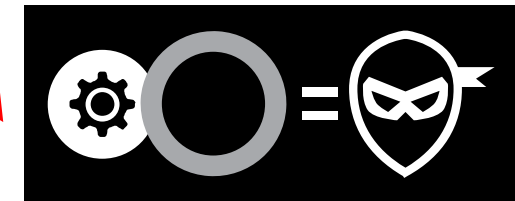

Press Trigger and Setup
buttons simultaneously –
repeat to remove

MDS-10 User Interface

GPR START/STOP GATES

Purpose: Reduce GPR false alarms due to rough or uneven surfaces and shallow or deep clutter

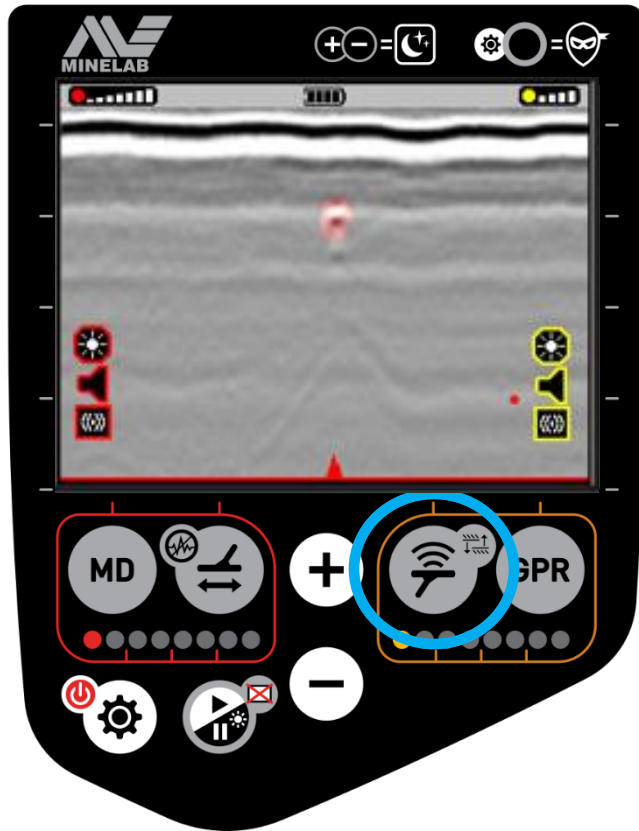

Long press of Skyshot button to display Stop and Start Gates

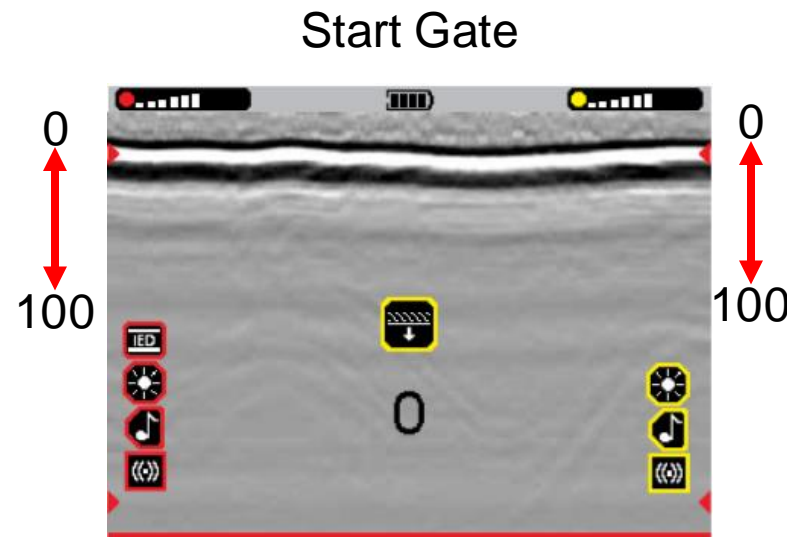

Press + and – buttons to lower or raise Start Gate

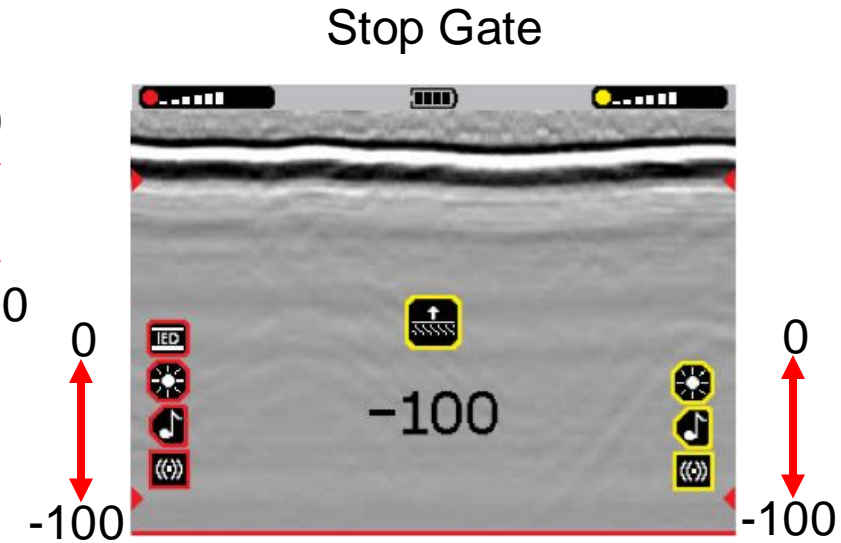

Press Skyshot button again to display Stop Gate icon and press + and – buttons to raise or lower Stop Gate

MDS-10 User Interface

GPR DETECTION THRESHOLD

Purpose: Adjusts ability of GPR to detect weak targets in GPR imagery

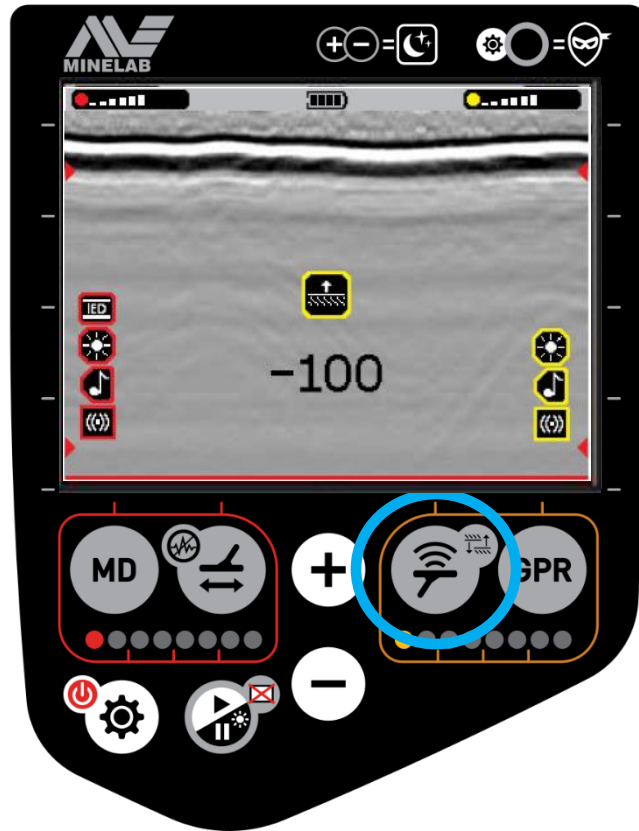

While in Stop Gate display press Skyshot button to display GPR Threshold icon

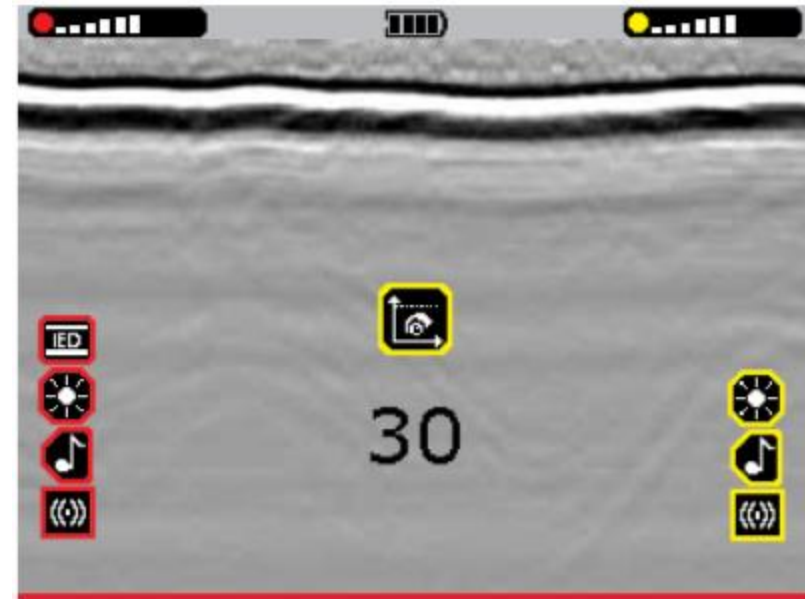

Press + and - to adjust Threshold between 0 and 100. Default is 30

MDS-10 Setup Options

SCREEN OVERVIEW

Purpose: Selects MD and GPR alerts, audio outputs and GB mode

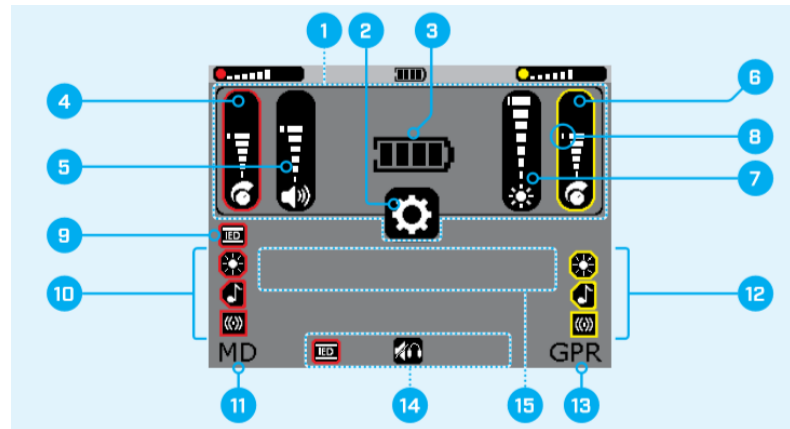
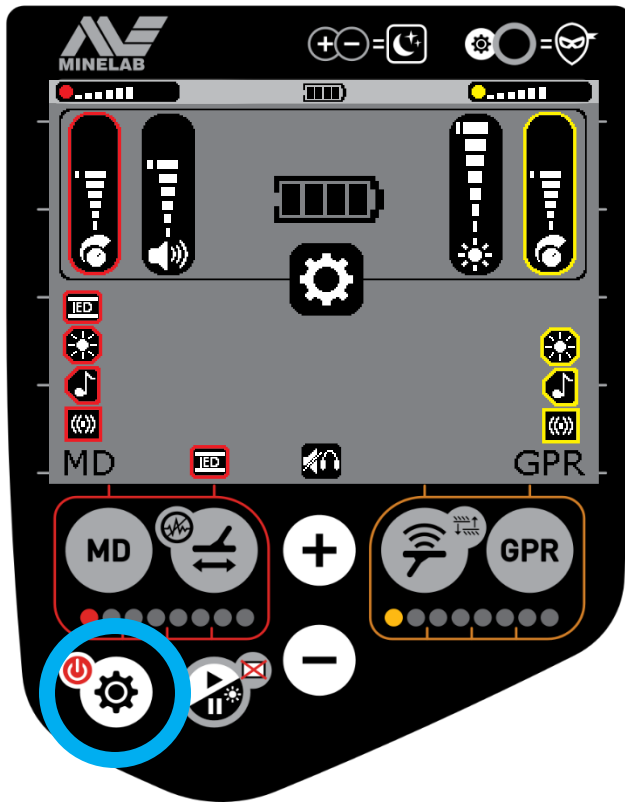

1. Setting Overview Area
2. Setup Menu Icon
3. Battery Level Indicator
4. MD Sensitivity Level
5. Volume Level
6. GPR Sensitivity Level
7. LCD/LED Brightness Level
8. Default Setting Markers
9. MD Ground Balance Mode
10. Enabled MD Feedback Indicators
11. MD Setup Page Indicator
12. Enabled GPR Feedback Indicators
13. GPR Setup Page Indicator
14. Soft Key Options
15. Error Code Display Area

Press Setup button to enter into the Setup screen where existing configuration of detector is displayed

MDS-10 Setup Options

MD & GPR ALERTS

Purpose: Use soft keys to select/deselect MD and GPR alerts

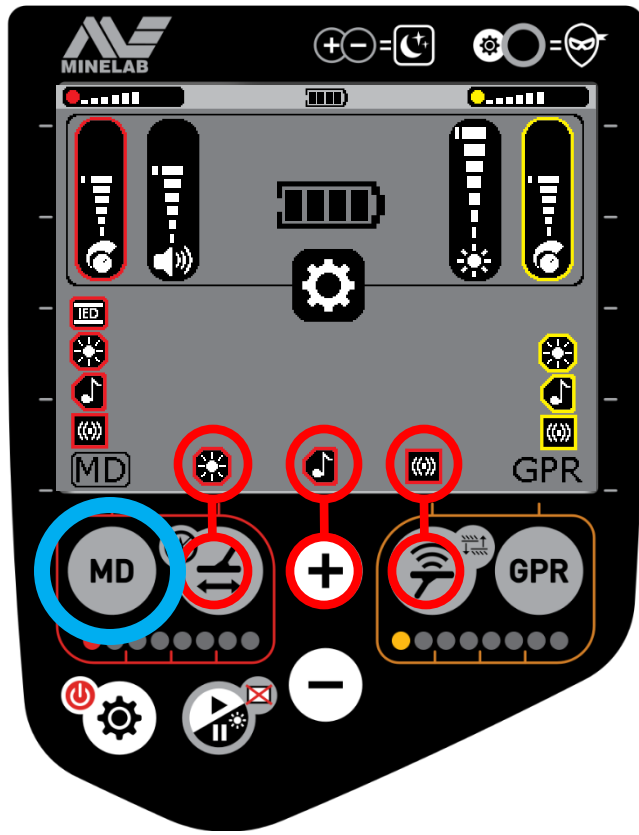

Note:

It is not possible to deselect all three alerts for each sensor simultaneously

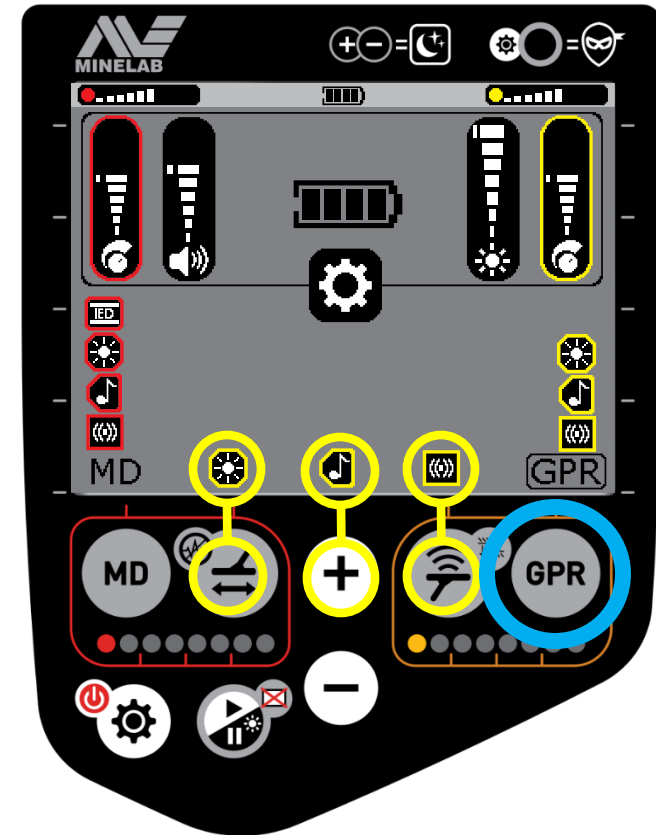

Press MD button to display MD alerts and press the soft key under each alert to select or deselect

Press GPR button to display GPR alerts and press the soft key under each alert to select or deselect

MDS-10 Setup Options

GROUND BALANCE MODE

Purpose: To select IED or Conventional (Bomb) mode

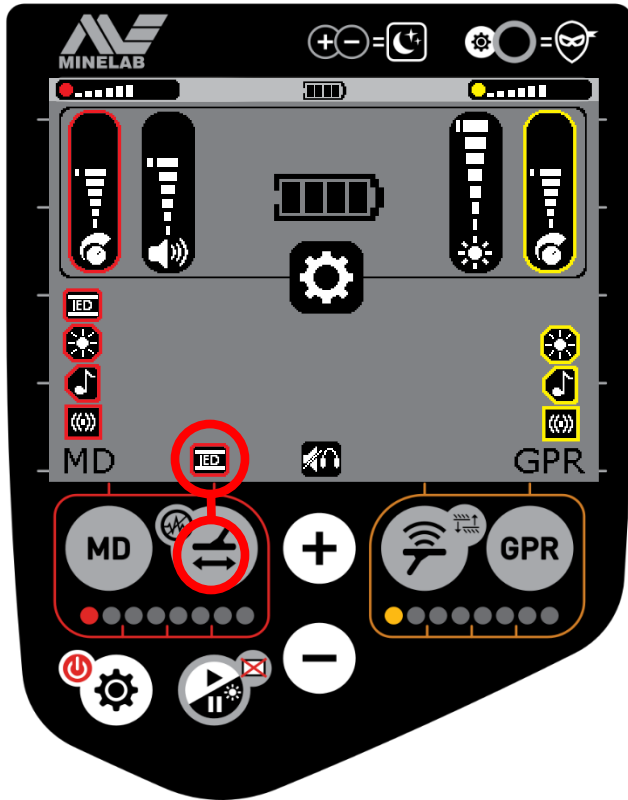

When in Setup screen existing GB mode is displayed

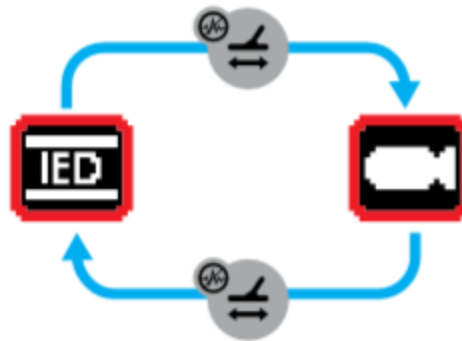

Press soft key to toggle between GB modes

Note:

- IED mode is default mode used to detect all metal targets including high frequency targets like wires and carbon rods
- Conventional mode is less sensitive to wires and carbon rods and can be used in salty ground such as beach locations

MDS-10 Setup Options

AUDIO OUTPUT MODES

Purpose: To select preferred Audio output

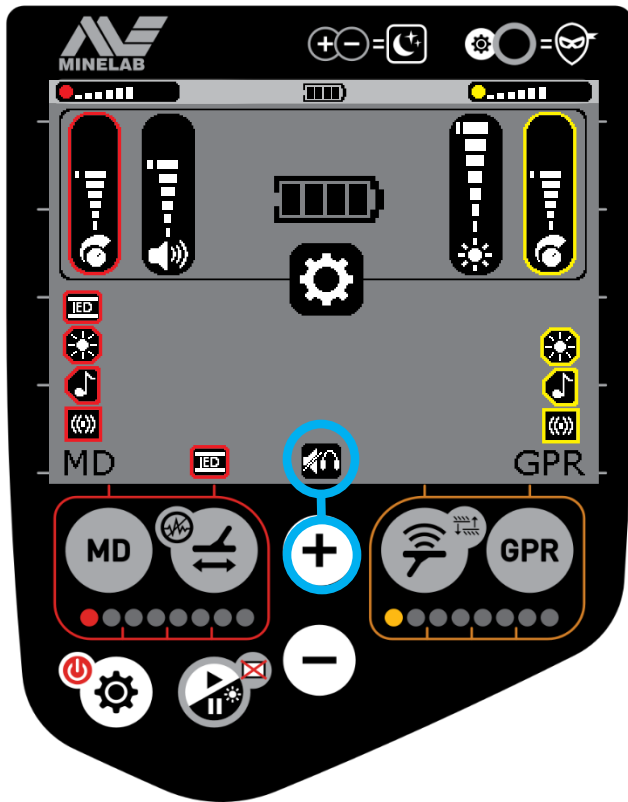

When in Setup screen existing Audio Output Mode is displayed



Speaker audio is automatically On if an earset is not connected. Speaker audio is automatically muted (Off) if an earset is connected.

Speaker and Earset On



Both the Speaker and the earset are On. This is a useful mode for training scenarios.

Speaker Off



Speaker audio is always Off, even if there is no earset connected.

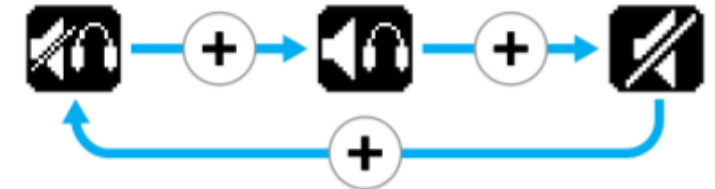

Press soft key to toggle between Audio Output Modes

Lesson 3

MD/GPR Overview & Search Techniques



MDS-10 MD Sensor

MD SENSOR MODES

Purpose: To detect, pinpoint and obtain information about a target

Detection Mode (Default)

- Maximum performance
- Dynamic mode
- Pitch and volume proportional to target signal strength
- More sensitive than Pinpoint or Interrogation modes

Pinpoint Mode

- Press and hold trigger
- Static mode

Interrogation Mode

- Press and release trigger
- Ferrous and non-ferrous indications
- Provides graphical information about target
- Indicates carbon rod detections
- Provides varied tones depending on target

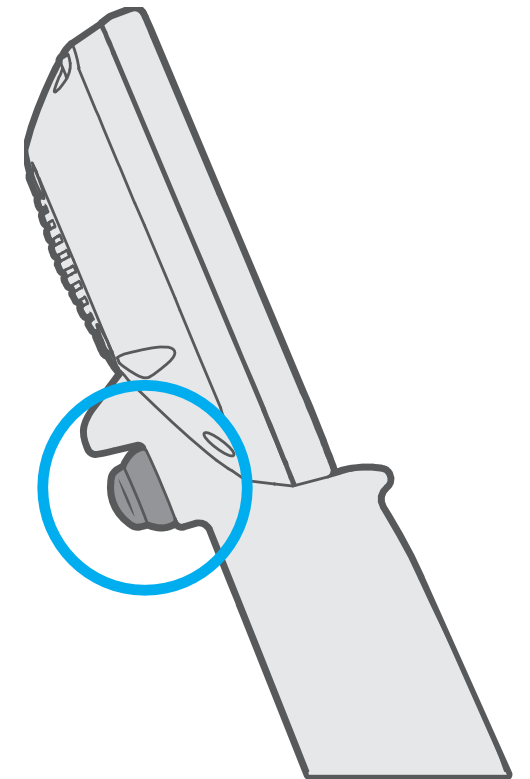
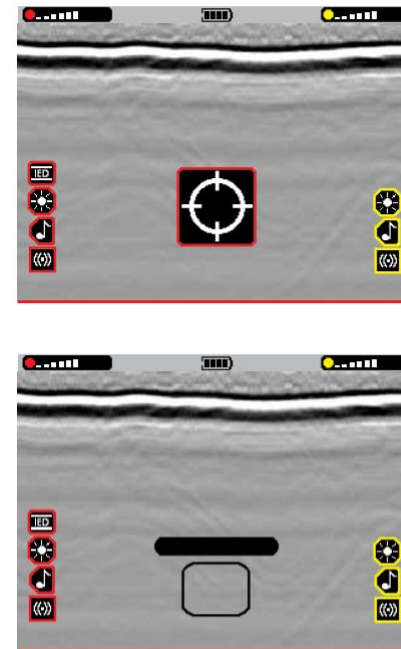

MDS-10 MD Sensor

MD INTERROGATION MODE

Purpose: To obtain information on characteristics and composition of target

Interrogation Mode

- Press and release trigger
- Ferrous and non-ferrous indications
- Provides graphical information about target
- Indicates carbon rod detections
- Provides varied tones depending on target

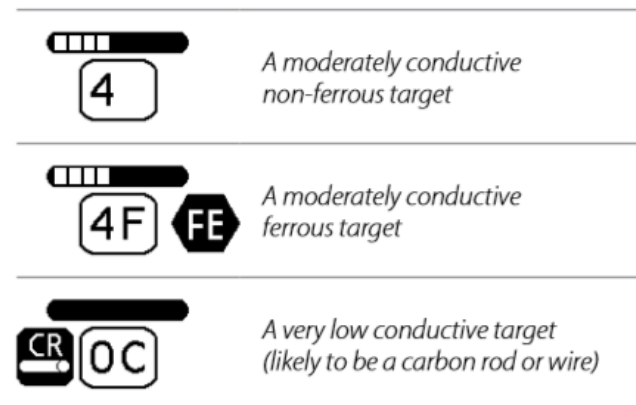
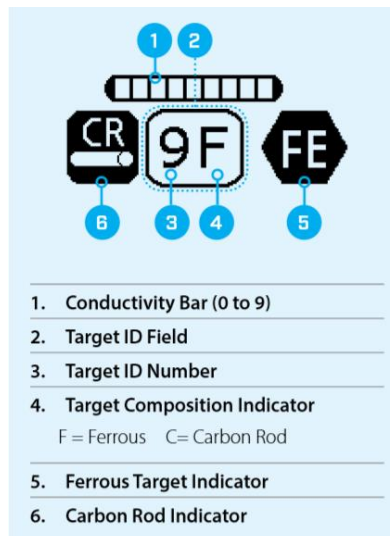
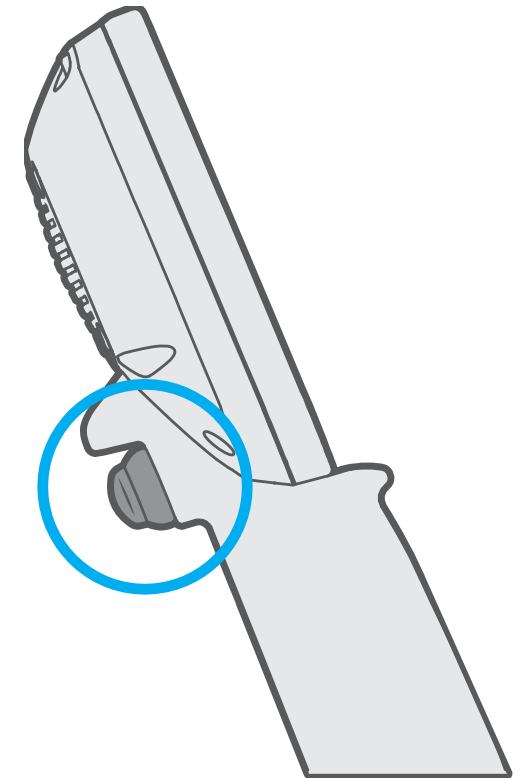
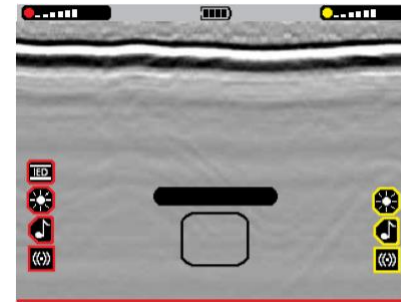

MDS-10 MD Sensor

MD TRACE

Purpose: Provides real time MD visual indication of target detection

Detection Mode

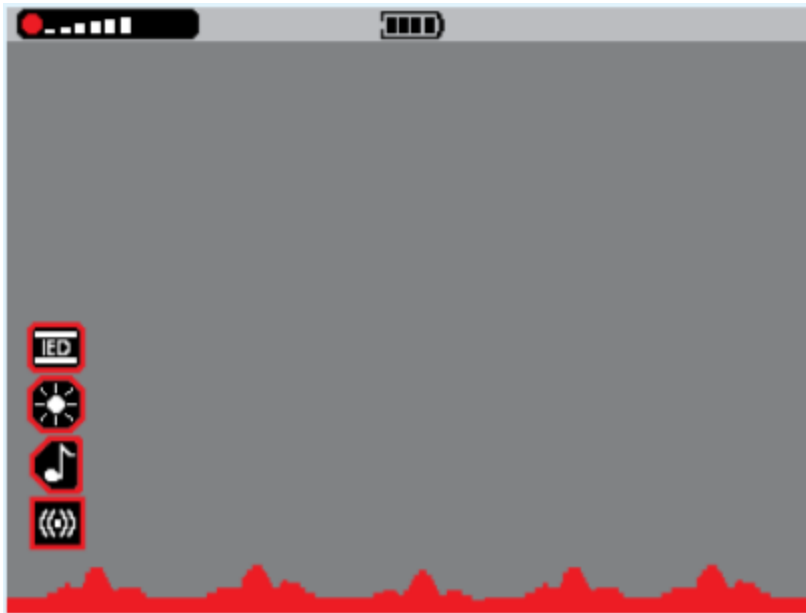

Small or deep metallic targets
4 seconds of data right to left

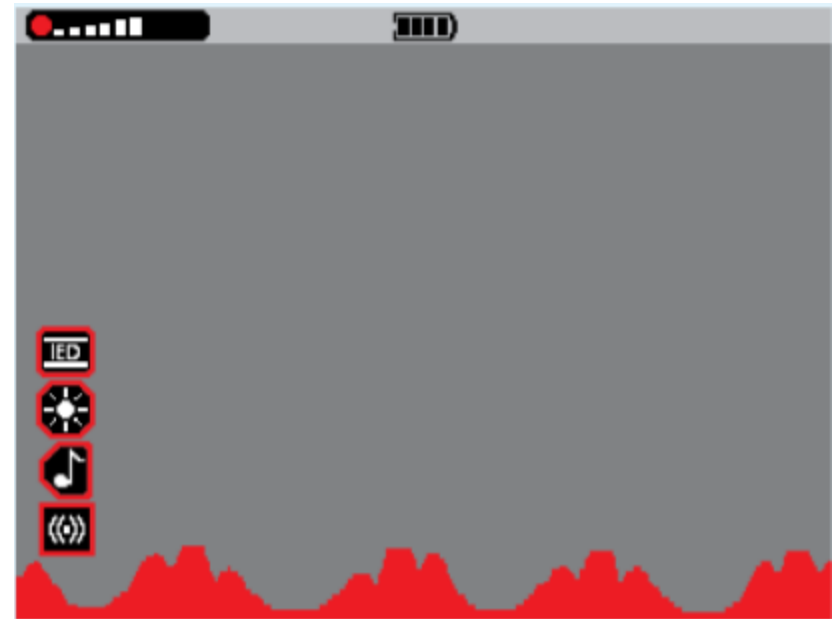

Large or shallow metallic targets
4 seconds of data right to left

MDS-10 GPR Sensor

GPR IMAGERY

Purpose: Provides real time GPR visual indication of target detection

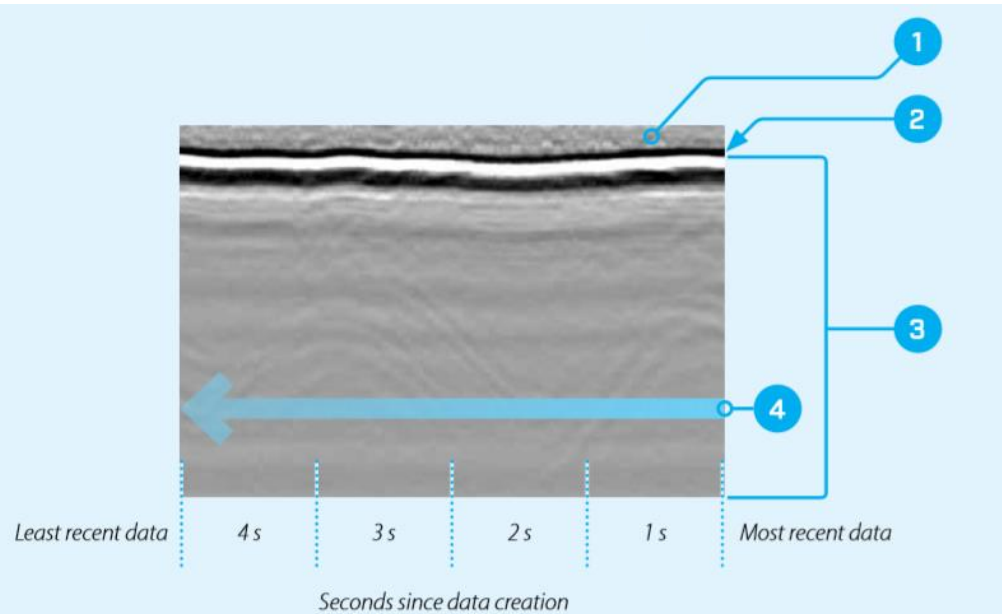

1. Air

The space from the bottom of the Sensor Head to the surface of the ground.

2. Ground surface response

The most prominent (dark and light) lines show the ground surface response.

3. Area under ground

Everything below the ground bounce line is displaying what is in the ground.

4. Data Flow

Arrow shows the direction of data flow across the screen from right to left.

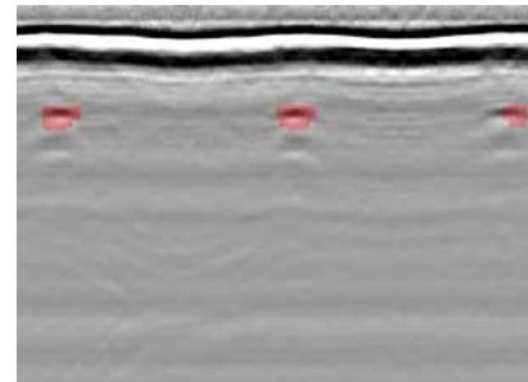

The GPR Image shows a typical detection. Anomalies are overlaid in red to facilitate recognition.

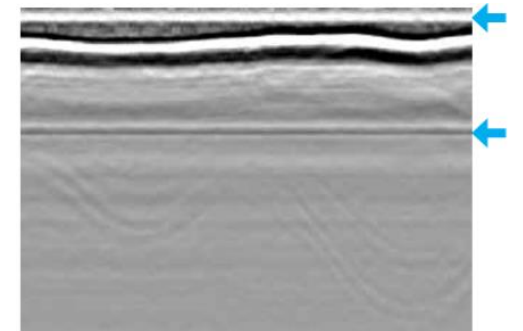

The GPR Image is noisy, making it difficult to identify true target signals among the erratic detections. Note the straight horizontal bands in the image, including above the ground surface. Skyshot procedure is required.

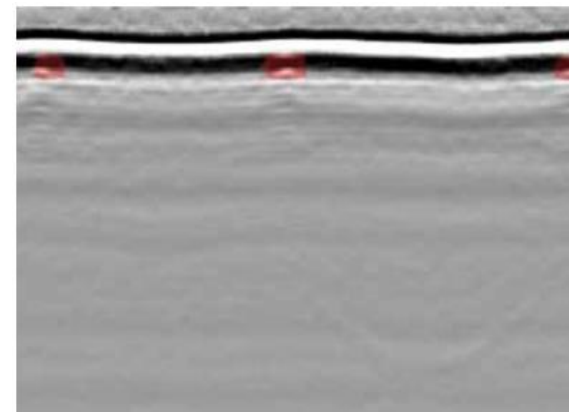

Small, shallow buried object detected.

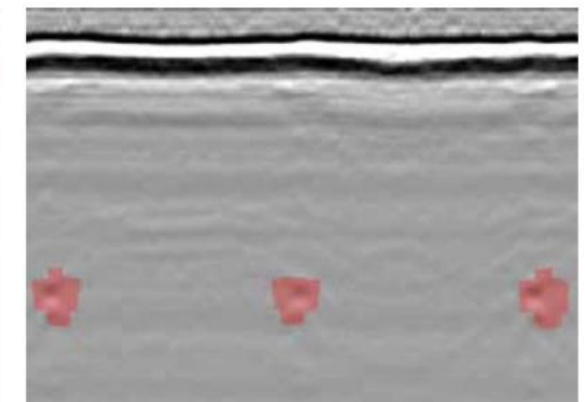

Deep buried object detected.

Parts of GPR imagery

Examples of GPR imagery

MDS-10 GPR Sensor

GPR MOTION DISABLE INDICATOR

Purpose: Stops GPR transmission during periods of inactivity

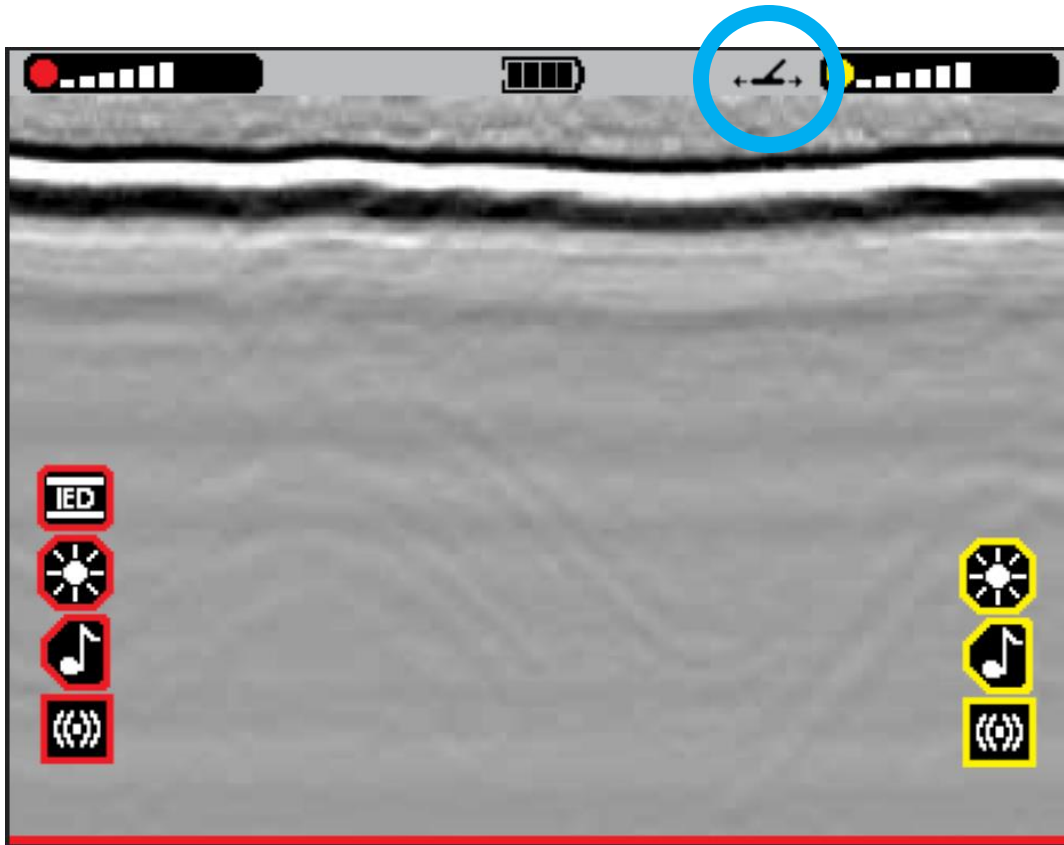

- After 8 seconds of inactivity
 - GPR transmission stops
 - Scrolling screen stops
 - Flashing icon 
- GPR transmission and scrolling screen resume upon detector movement

MDS-10 MD & GPR Sensors

DISPLAY & GPR IMAGERY

Purpose: Provides real time combined MD and GPR visual information

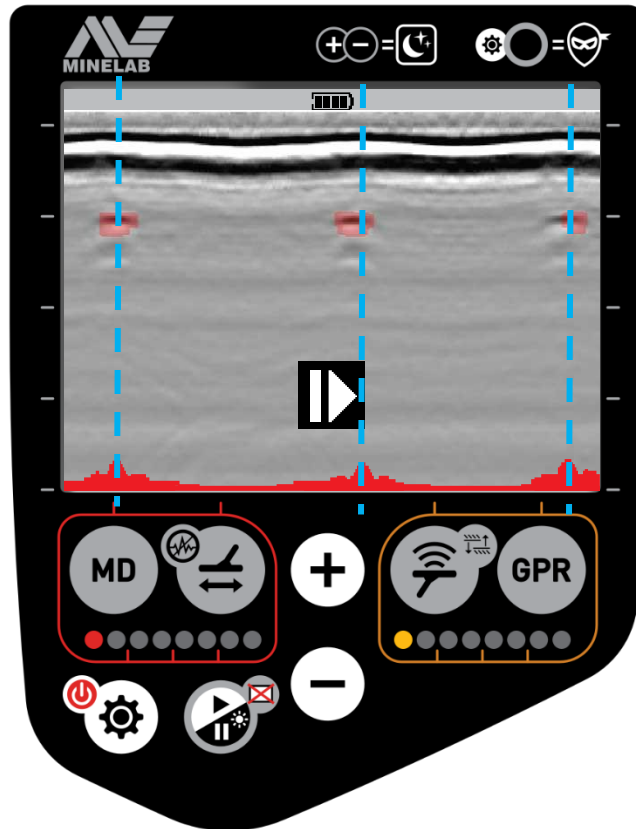

Note:

Alignment of MD and GPR traces indicate target is an anomaly in the ground and contains metal

MDS-10 Search Technique

Search Speed



- Smooth motion 0.5 to 1 m (1.5' to 3') / sec

Search Overlap

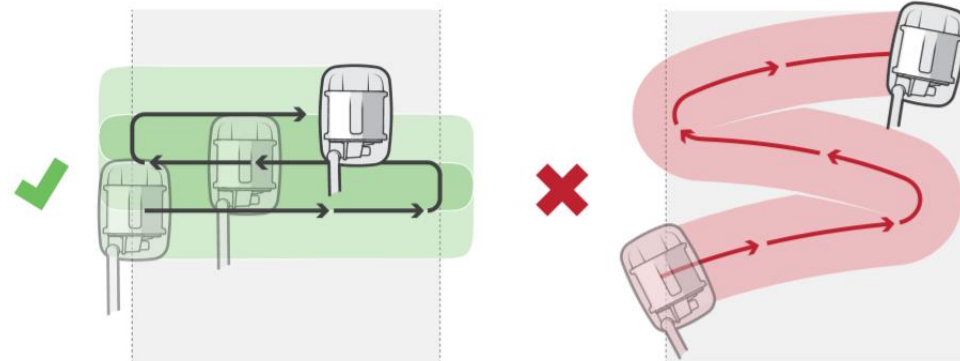

- Half coil overlap

Search Height

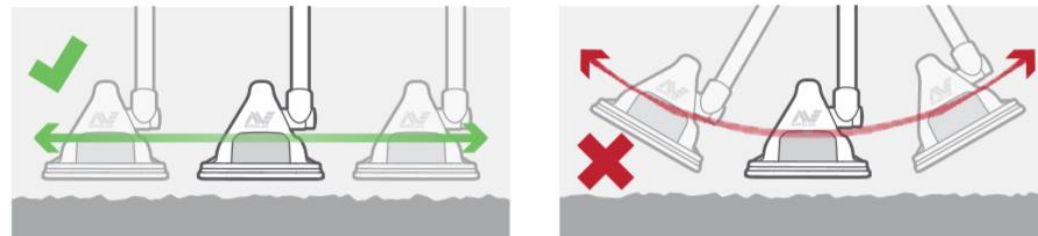

- Parallel sweeping
- 25-50mm 1-2"
- MD only sweep closer
- GPR no closer than 25mm

MDS-10 Locating the Target

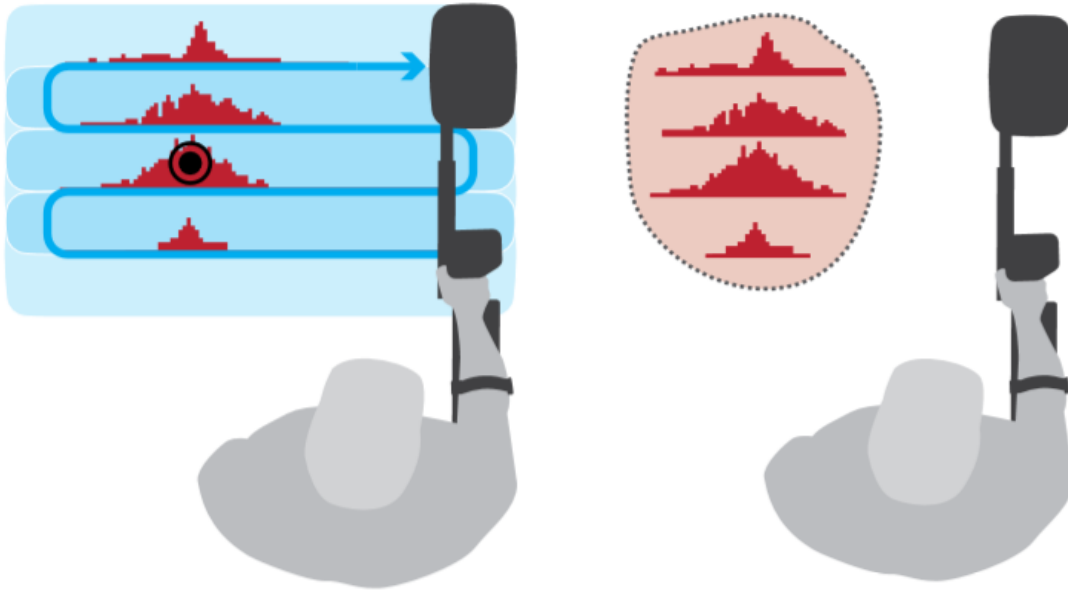

In detection mode, once MD and/or GPR sensors give target indications attempt to sweep to cleared ground and obtain a mental image of the suspicious area

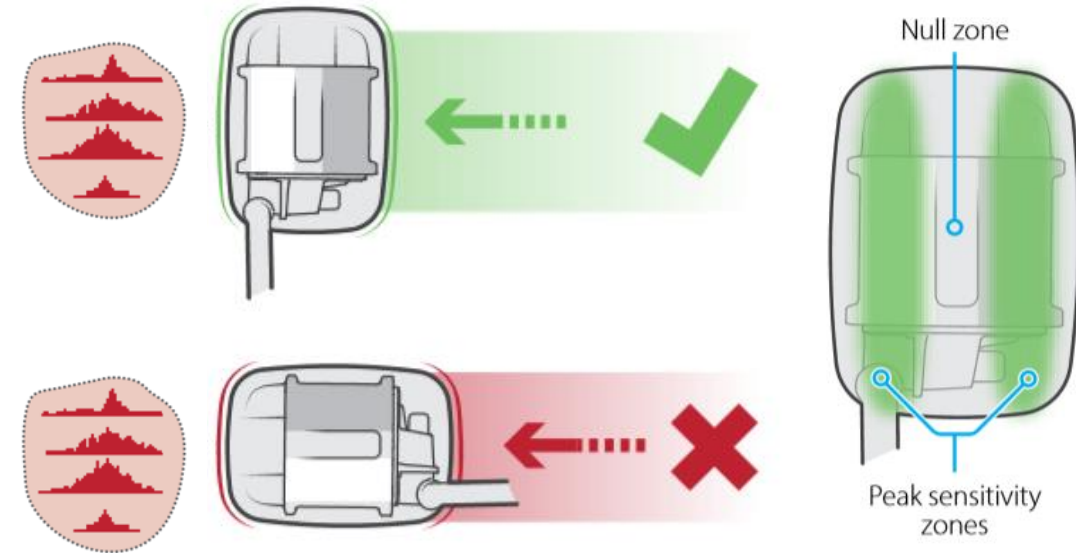

Select pinpoint mode and commence mapping the target by approaching with the long side of the search head

MDS-10 Locating the Target

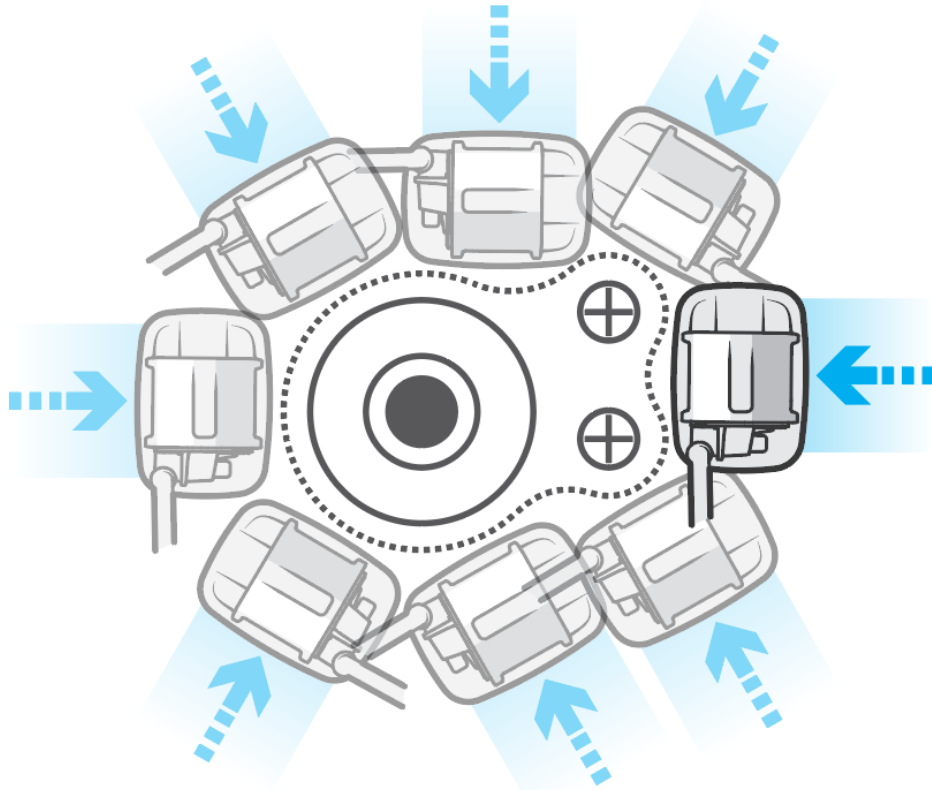

For targets including multiple targets, approach from several angles to map out the area

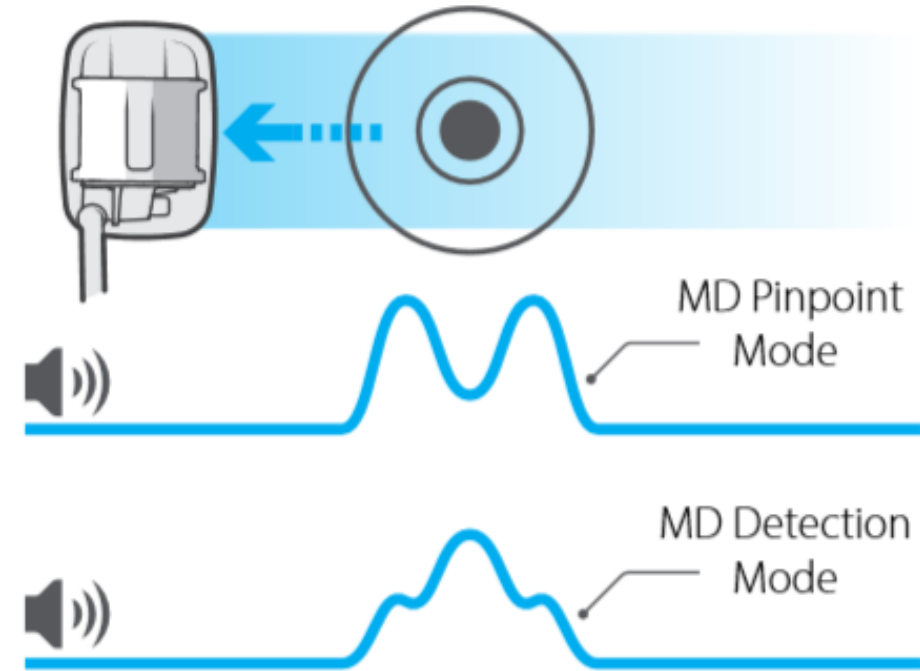

When moving over a target detection mode and pinpoint mode give a different number of tones

MDS-10 Pinpointing the Target

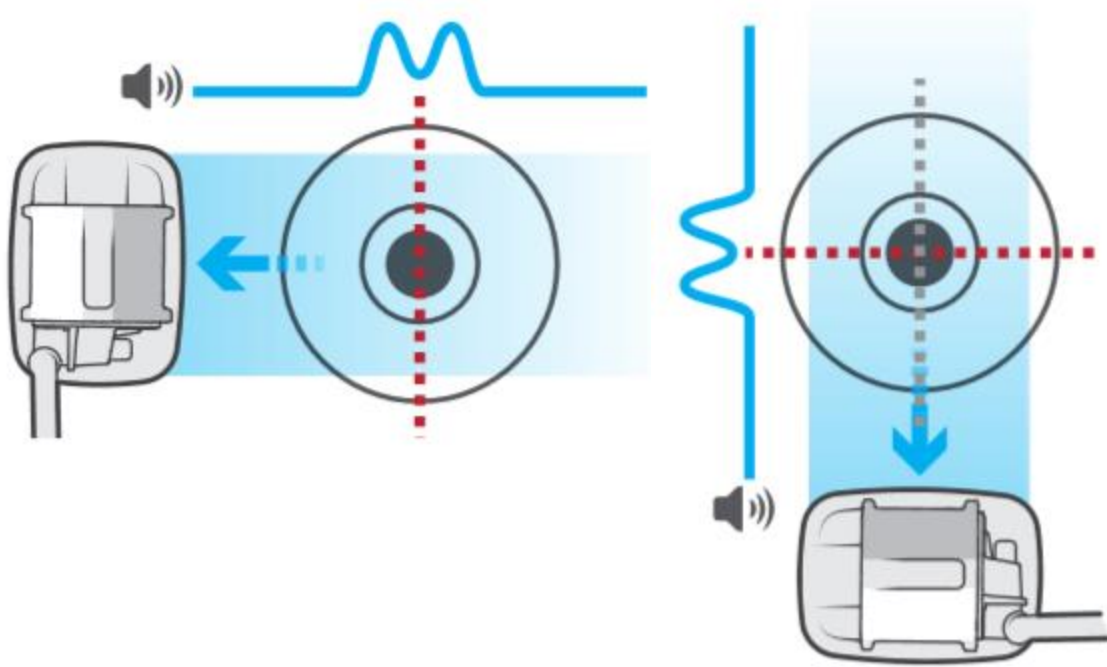

In pinpoint mode sweep the target at 90 degrees noting the loss of tone (null point). Extremely accurate pinpointing can be achieved

Pinpointing of AT, AP mines and crushed wire fuse

Lesson 4

Accessories, Possible Faults, Maintenance



Accessories

LITHION-ION BATTERY CHARGER & PACK

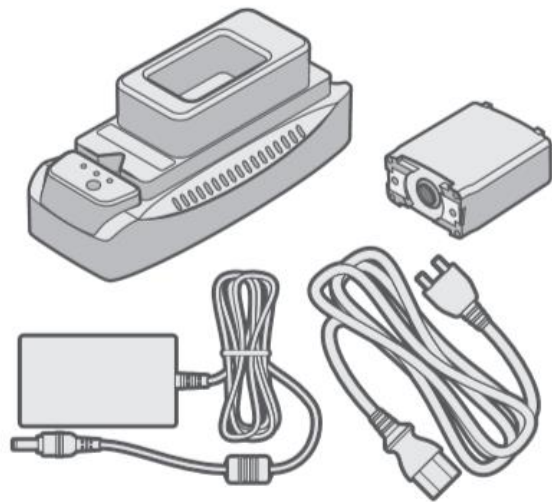

Battery Charger, AC power pack, AC power cable battery pack

	75% – 100%
	50% – 75%
	25-50%
	5-25%
	<5% (Flashing, Charging required)

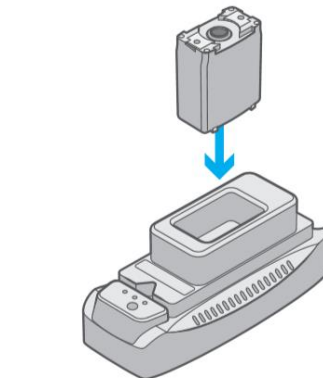
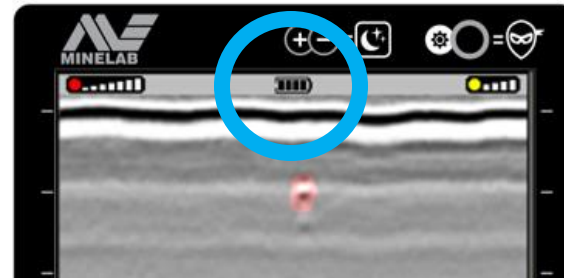

Battery Pack Status



Charge status LEDs and the Condition button on the Lithium-ion charger.

	Amber solid	Charging
	Amber flashing	Conditioning
	Green solid	Charging complete
	Red solid	Fault <i>Battery may be faulty or may need to be conditioned.</i>
	Red Flashing	Temperature error <i>Charging paused due to temperature (too hot/cold).</i>

Battery Charger Status

Accessories

OPTIONAL AA BATTERY PACK

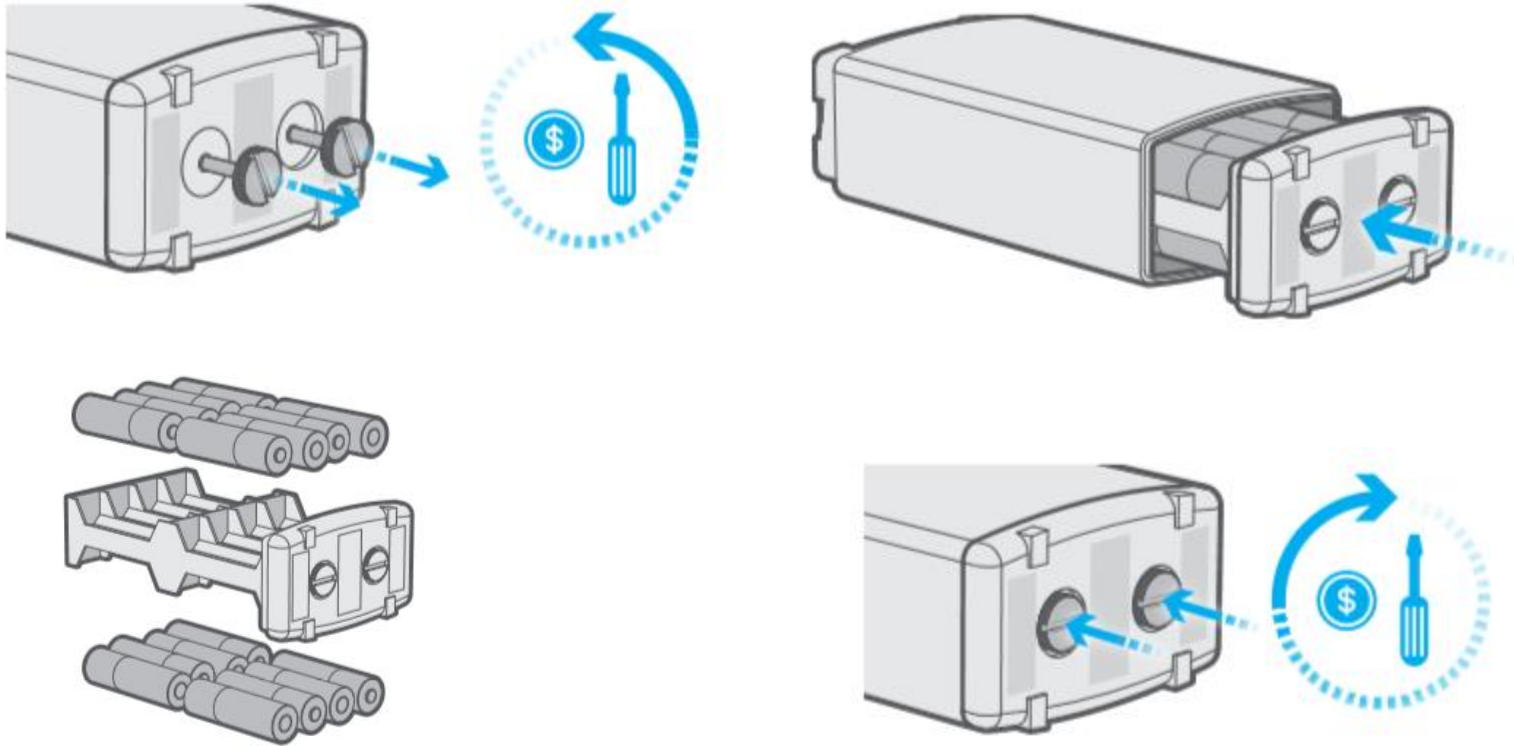

Note:

- Until low battery alert, detection performance is consistent
- Battery alert indication is one or more of:
 - Flashing battery icon on display
 - Rapid high-low audio tone every 10 seconds
 - Three rapid vibrations every 10 seconds
- Upon low battery alert, replace batteries immediately

16 x AA alkaline batteries

Possible Faults

TROUBLE SHOOTING

Problem	Recommended Action
Detector will not turn On	<ol style="list-style-type: none"> 1. Ensure that the battery is charged. 2. Remove and refit the battery.
No LEDs/Audio/ Vibration	<ol style="list-style-type: none"> 1. Check that the LED, Audio, or Vibration Feedback Settings are On for each sensor (page 25). 2. Ensure that Night Vision Mode is disabled (page 24). 3. Ensure that Tactical Mode is disabled (page 26).
LCD display is not working	<ol style="list-style-type: none"> 1. Check that the LCD is On (page 24). 2. Ensure that Night Vision Mode is disabled (page 24). 3. Ensure that Tactical Mode is disabled (page 26).
No sound - Speaker	<ol style="list-style-type: none"> 1. Check the Audio Output Mode is not set to 'Speaker Off' (page 27). 2. Check the Audio Output Mode is not set to 'Speaker Auto-Mute' with an Earset connected (page 27). 3. Check the Volume is set to an audible level (page 27). 4. Check the Audio Feedback Settings are enabled for the applicable sensor (page 25) 5. Check the applicable Sensor is enabled (MD page 29, GPR page 36).
No sound - Earset	<ol style="list-style-type: none"> 1. Check the earset is properly connected. 2. Check the Volume is set to an audible level (page 27). 3. Check the Audio Feedback Settings are enabled for the applicable sensor (page 25) 4. Check the applicable Sensor is enabled (MD page 29, GPR page 36). 5. Remove the earset and inspect the connectors for contamination or damage. 6. Replace the earset.



Do not attempt to remove mud with a sharp tool. This may cause damage to the speaker.

1. Gently rinse the speaker under clean water to soften and remove mud. Rinse until the water runs clear.
2. If the mud will not soften, the speaker grill will need to be removed and cleaned by a service technician.

Speaker grill blocked



The Speaker Grill on the rear of the User Interface.

Error Code is displayed on the LCD

1. Power the detector Off then On again.
2. If the Error Code persists, refer to Error Codes on page 58.

Trouble Shooting - Refer to Operations Manual

Possible Faults

ERROR CODES

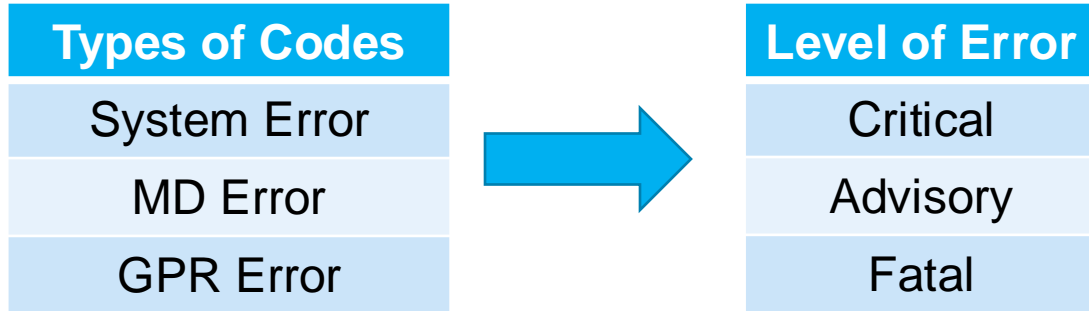

Error Codes - Refer to Operations Manual

Possible Faults

ERROR CODES

Types of Codes
System Error
MD Error
GPR Error



Level of Error
Critical
Advisory
Fatal

Affects detector performance

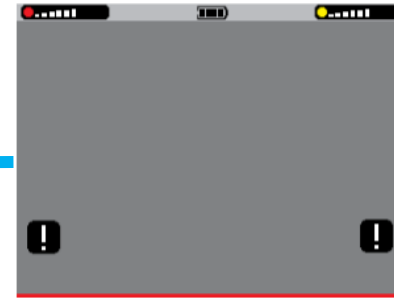

MD & GPR



System

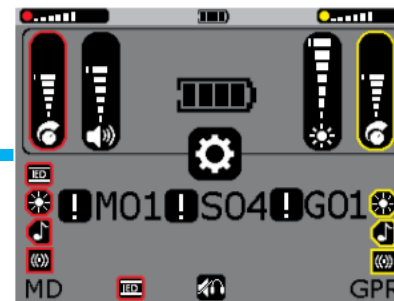

Error Codes
(Setup Screen)

Action

- Attempt to reset by powering off detector
- If necessary deselect affected sensor
- View error code in setup screen
- Report error

Error Codes - Refer to Operations Manual

Possible Faults

ERROR CODES

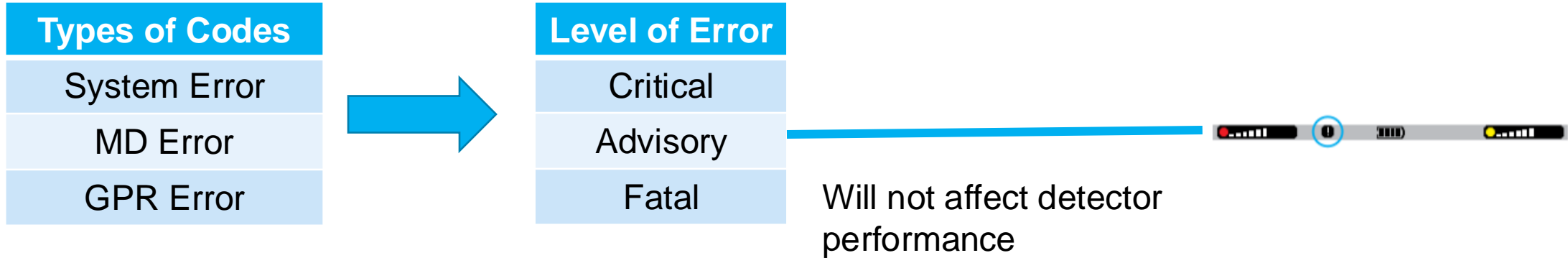

Action

- Elect to continue detecting
- View error code in setup screen
- Report error

Error Codes - Refer to Operations Manual

Possible Faults

ERROR CODES

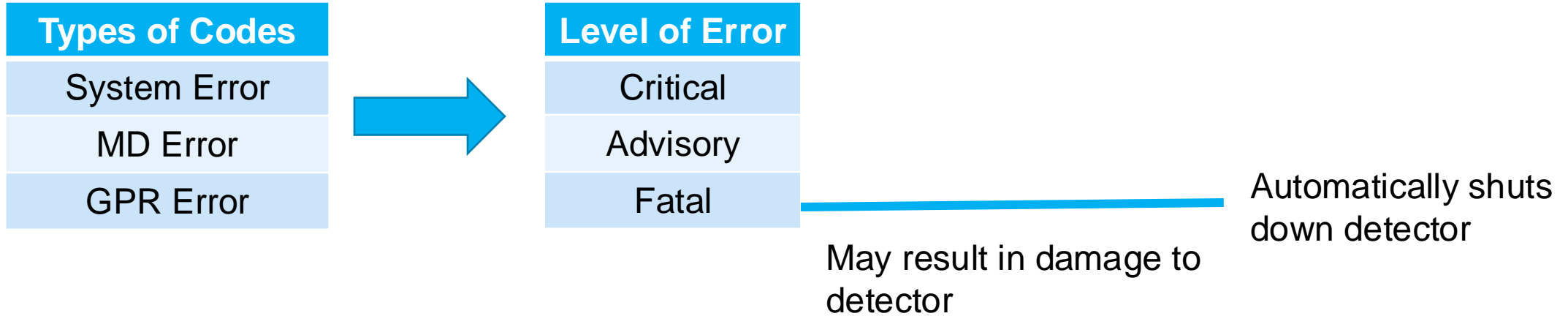

Action

- No error codes displayed
- Attempt factory reset
- Report error

Error Codes - Refer to Operations Manual

Course Summary & Revision



MDS-10 Kit Contents	Night Vision and Tactical Mode
Unfolding and Folding	GPR Start and Stop Gates
Description and Identification	GPR Detection Threshold
MDS-10 Quick Start	MD and GPR Alerts
Switch On Select Sensors	Ground Balance Mode
Ground Balance	Audio Output Modes
Noise Cancel	MD Sensor Modes
Skyshot	GPR Motion Disable
Volume and Sensor Sensitivity	Search Technique
Pause and Screen Brightness	Battery Charger

Operator Confirmation Exercise

BRIEFING



MDS-10
Dual Sensor Detector

This is to certify that

of

has successfully completed the Minelab
MDS-10
Operator Training course

Signed: _____

Date: _____

MINELAB

All Mines - All Soils - All Conditions

Annex A

Frequently Asked Questions

a. Environmental concerns.

(1) *Max and min operating temperatures?*

- -30°C to +60°C Tested

(2) *Battery life for the above?*

- 7 hours run time at 25°C. Run time will be slightly less at the extremes of temperature range.

(3) *Submergible depth?*

- 3m

(4) *Effect of ground conditions on detect capability:*

- MD capability will not be significantly affected by ground conditions.
- GPR will be affected by some ground conditions. For example a freshly ploughed field will have anomalous soil, some clumps and some voids and as such would detract from the GPR capability.

(a) *Does ground water affect detection?*

- MD minimal to no affect.
- GPR yes. Ground water and soil moisture will affect capability, in line with other existing GPRs.

Frequently Asked Questions

(b) Laterite/bauxite soils effect on detection. Mineral compensation requirements?

- MD has ground balance function to minimum effect of mineralised and magnetic soils. Ground balancing to very difficult soils will result in very aggressive ground balance settings which will likely have some decrease in performance, not very significant or noticeable.
- GPR will be affected, laterite soils have higher losses to GPR and that will reduce detection depth compared to sand or more benign soils.

(c) Effect of ground composition on detection. i.e. gravel, compact soil, mud, moon dust, rubblised urban etc?

- MD Ground composition will have no effect on capability of the MD.
- GPR Ground composition will affect the GPR. For example ground with voids and air pockets like rubble will tend to have more noise and false alarms, as is the case with other in service GPR (Minehound)

(d) Effect of sub/supersurface utilities on detection, primarily electric cables.

- The MD is capable of detecting wires and in many cases can detect and map out the location of wires. The MDS-10 is incredibly immune to interference and will be able to operate effectively whilst quite close to electrical utilities and cables. Dependant on specific details (current, voltage and earth of utilities)
- GPR not affected by utilities and electrical cables

Frequently Asked Questions

b. Integration Issues:

(1) Interoperability with other MDS-10 or HORN Mk3.

- MD can operate as close as 2m from another MDS-10 detector. We don't have details on the HORN Mk3.

(a) Operating distances from each other?

- Minimum two meters.

(b) Ability to change frequency?

- MD, yes Noise Cancel function will automatically select the quietest (least interference) frequencies.
- GPR ultra wide band width so frequency changing is not required.

(2) Distance from ECM.

- Dependant on specific ECM.
- MD is incredibly immune to interference and ECM due to figure 8 Rx coil. We have successfully operated the MD in close proximity to ECM with no instances of interference. Not tested on all ECM yet. MD meets Mil Std 461G RS103 (20v/m)

(3) TTPs.

- MDS-10 Operations Manual, Operator training ppt

Frequently Asked Questions

(a) Interchangeable TTPs with existing core detectors.

- Whilst MDS-10 user interface and controls are different to existing core detectors the MDS-10 user interface is designed to be intuitive and requires less training than existing core detectors.

(b) Sweep speed/style.

- MD is very tolerant of very high swing speeds with reasonable detection results at speeds of up to 1.5m per second. Sweep speed and style is similar to other dual sensors. The MDS-10 is significantly lighter and more versatile than other dual sensor detectors so operators will have more control, balance and less fatigue than other dual sensor detectors.
- GPR will lose some capability at swing speed of greater than 1m per second, particularly on small and very difficult targets.

Frequently Asked Questions

(c) *Methods of delineation. Is it the same in all functions?*

- MD has three distinct and different operating modes that offer optimised delineation as follows:
 - Detection Mode: Very responsive, very sensitive with low latency and fast recovery. Ideal for searching new ground and detecting all targets. Detection mode is dynamic (AC coupled) where the MD characterises the targets size and proximity.
 - Pin point mode: Static detection (DC coupled) detection is decoupled from movement (swing speed). Pin point mode is ideal for mapping (discovering size and shape) know targets.
 - Interrogate Mode: Less sensitive and less responsive than detection mode. Interrogate mode characterises the targets conductivity and ferrous content (type of metal) so is capable of distinguishing one target type from another. For example low pitched tone to ferrous targets (FE indicator), high pitched tone to conductive items (high conductivity ID number) and a specific carbon rod indicator for carbon rods (conductive non-metals) and fine wires.
 - GPR displays a B-scan on the display, this image characterises the size and shape of the target with the depth of the target clearly shown on screen. The GPR audio tone indicates the depth of the target, high pitched GPR tone for shallow targets, low pitched GPR tone for deep targets.

Frequently Asked Questions

(d) Detection methodology.

- Cut and paste content from brochure/manual

(e) Min distance from EEDs, Pre/post destruction/exposed EEDs.

- Dependant on specifics of the actual EED (Electro Explosive Device). Minelab do not have specific safety stand-off distances between the MDS-10 and EEDs. Testing to date has shown the MDS-10 doesn't initiate magnetic influence mines.

(4) Competency metrics.

- As per the conformation exercise document.

(a) A defined user package.

- Suite of released documents and materials.

(b) Min hrs/days to become competent.

- Two (2) full days training for an operator with previous detector experience.

(c) Confidence checks. How often?"

- Conduct test piece checks every time the MDS-10 is started.